



AdderLink Infinity

User Guide

{ ALIF1000
ALIF2000



[CONTENTS](#)

Contents



Introduction

AdderLink ALIF1000T and ALIF1000R unit features	3
AdderLink ALIF2000T and ALIF2000R unit features	4
What's in the box (ALIF1000)	5
What's in the box (ALIF2000)	6
What you may additionally need	7

Installation

Mounting	8
Connections	9
TX video link	10
TX audio links	11
TX USB link	12
TX AUX port	12
TX power in	13
Power adapter identification	13
TX/RX network link	14
RX video display	15
RX microphone & speakers	16
RX USB devices	17
RX AUX port	17
RX power in	18
Power adapter identification	18

Configuration

Initial configuration	19
Manual factory reset	19
Infinity browser-based configuration utility	20
Performing an upgrade	21

Operation

Front panel indicators	22
------------------------------	----

Further information

Getting assistance	23
Appendix	24
RS232 'null-modem' cable pin-out	24
Supported video modes	24
ALIF 1000 general specifications	24
ALIF 2000 general specifications	24
Warranty	25
Safety information	25
Radio Frequency Energy	26

Index

INSTALLATION

CONFIGURATION

OPERATION

FURTHER INFORMATION

INDEX

Introduction

Thank you for choosing AdderLink Infinity, otherwise known as ALIF. ALIF represents a major advance in the capabilities of digital extenders and switches. By encoding high quality DVI video, digital audio and USB connections into Internet Protocol (IP) messages, ALIF offers highly advanced and flexible signal switching capabilities.

Adder's extensive knowledge of interfacing techniques and high speed networking has allowed us to develop new ways to break the chains of local DVI, USB and audio connections. With ALIF, distance is finally no barrier to high specification, high performance computing. Furthermore, since all signals are now IP, the most elaborate and yet simple-to-use switching and multicast techniques make possible a great variety of uses.

There are two main models within the ALIF family:

- ALIF1000 supports one single link DVI video stream, plus microphone, speakers and up to four USB peripherals. ALIF1000 units are linked using Gigabit Ethernet.
- ALIF2000 supports either two single link DVI video streams or one dual link (very high resolution) DVI video stream. This is in addition to microphone, speakers and up to four USB peripherals. ALIF2000 units can be linked using Gigabit Ethernet or Fibre Optic Links.

In both model types, there is a TX transmitter and an RX receiver. The former attaches to a single computer; the latter to your DVI video monitor, microphone, speakers and up to four USB peripherals. The distance between them is limited only by the size of your network.

In addition to separating one computer and its peripherals, ALIF promotes sharing. You can arrange for a limitless number of screens and speakers, distributed anywhere across the network, to receive video and audio. You can also switch between any number of transmitter units from a single screen, keyboard and mouse in order to monitor a potentially vast collection of remote systems.

All units feature browser-based configuration utilities to allow quick and easy set up, from near or far.

One-to-one configuration

The simplest configuration links one RX unit to a single TX unit, either by a direct link or over much greater distances via a Gigabit (or Fibre) Ethernet network.



One-to-many configuration

Using multicast techniques, an unlimited number of receivers* can receive video and audio data streams from a single TX unit.

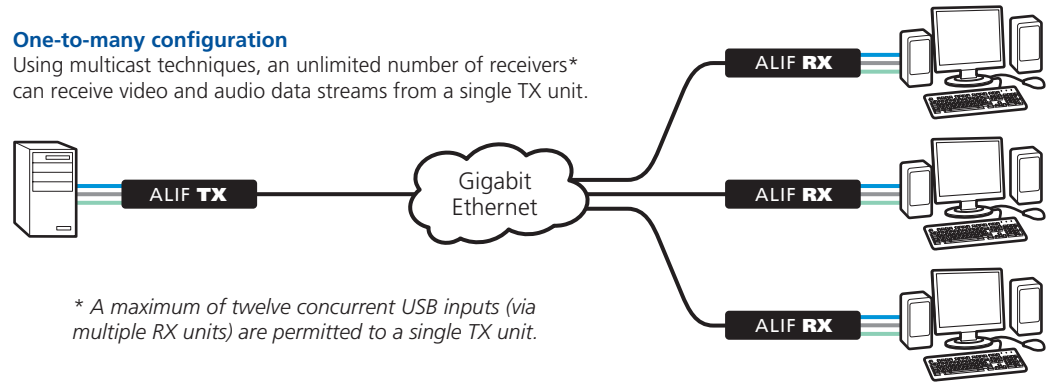

** A maximum of twelve concurrent USB inputs (via multiple RX units) are permitted to a single TX unit.*

Mixing ALIF1000 and ALIF2000 units

It is possible to mix ALIF1000 and ALIF2000 transmitters and receivers. The only exception is that the ALIF1000 units do not support dual link DVI video signals.

AdderLink ALIF1000T and ALIF1000R unit features

The ALIF1000 units are housed within durable, metallic enclosures with most connectors situated at the rear panel - only the Ethernet ports are situated at the front panel. The smart front faces feature the operation indicators.



ALIF1000T (transmitter) - front

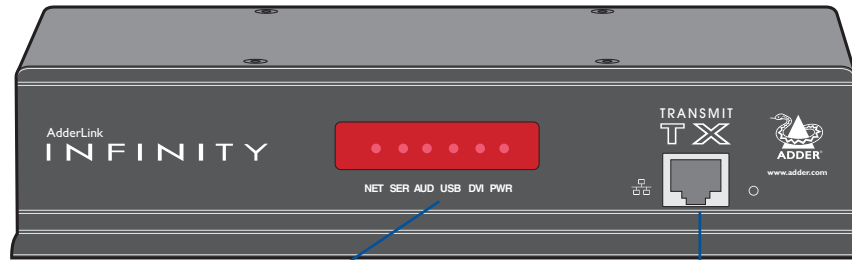

Indicators

Gigabit Ethernet port

These six indicators clearly show the key aspects of operation:

- **NET** On when valid network link is present. Flashes when the unit is in error.
- **SER** On when the AUX (serial) port is enabled and active.
- **AUD** On when audio is enabled and active.
- **USB** On when USB is enabled and active.
- **DVI** On when DVI video is enabled and active.
- **PWR** Power indicator.

ALIF1000R (receiver) - front

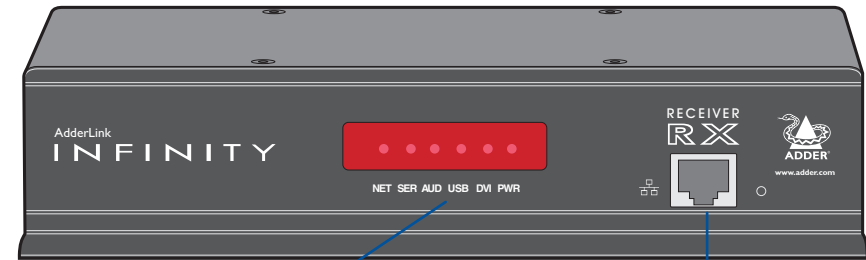

Indicators

Gigabit Ethernet port

These six indicators clearly show the key aspects of operation:

- **NET** On when valid network link is present. Flashes when the unit is in error.
- **SER** On when the AUX (serial) port is enabled and active.
- **AUD** On when audio is enabled and active.
- **USB** On when USB is enabled and active.
- **DVI** On when DVI video is enabled and active.
- **PWR** Power indicator.

ALIF1000T (transmitter) - rear

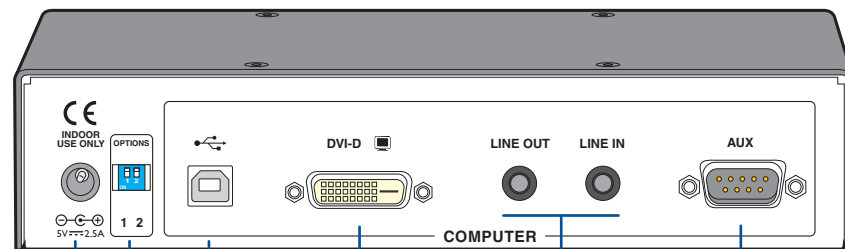

Power input

USB port

Video input

Audio line in/out

AUX (serial) port

Configuration switches

ALIF1000R (receiver) - rear

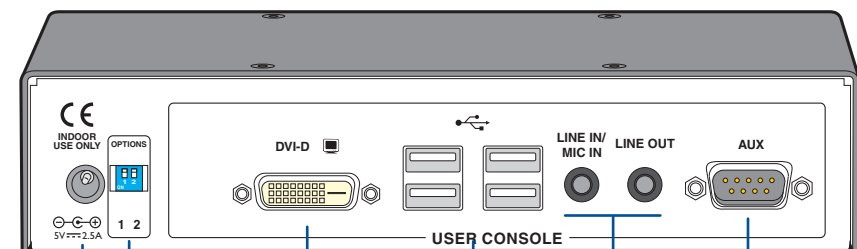

Power input

Video output

USB ports

Audio line in/out

AUX (serial) port

Configuration switches

INSTALLATION

CONFIGURATION

OPERATION

FURTHER INFORMATION

INDEX

AdderLink ALIF2000T and ALIF2000R unit features



The ALIF2000 units are housed within durable, metallic enclosures with most connectors situated at the rear panel - only the Ethernet and fibre ports are situated at the front panel. The smart front faces feature the operation indicators.

ALIF2000T (transmitter) - front

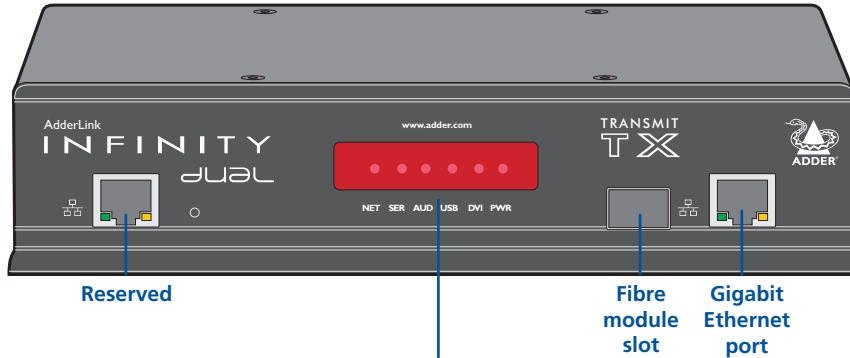

Reserved

Indicators

Fibre module slot
Gigabit Ethernet port

These six indicators clearly show the key aspects of operation:

- **NET** On when valid network link is present. Flashes when the unit is in error.
- **SER** On when the AUX (serial) port is enabled and active.
- **AUD** On when audio is enabled and active.
- **USB** On when USB is enabled and active.
- **DVI** On when either or both DVI Video channels are enabled.
- **PWR** Power indicator.

ALIF2000R (receiver) - front

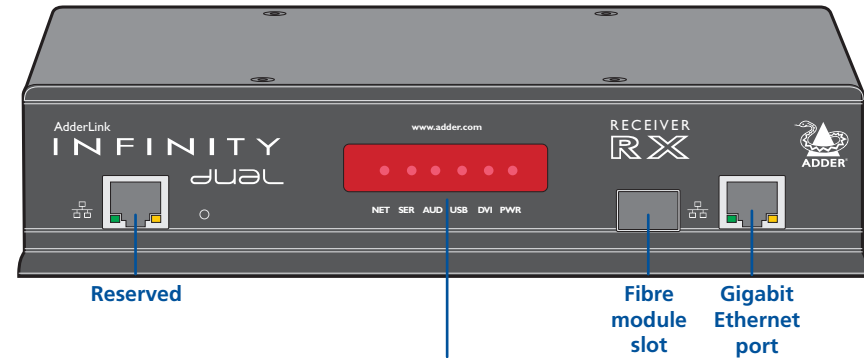

Reserved

Indicators

Fibre module slot
Gigabit Ethernet port

These six indicators clearly show the key aspects of operation:

- **NET** On when valid network link is present. Flashes when the unit is in error.
- **SER** On when the AUX (serial) port is enabled and active.
- **AUD** On when audio is enabled and active.
- **USB** On when USB is enabled and active.
- **DVI** On when either or both DVI Video channels are enabled.
- **PWR** Power indicator.

ALIF2000T (transmitter) - rear

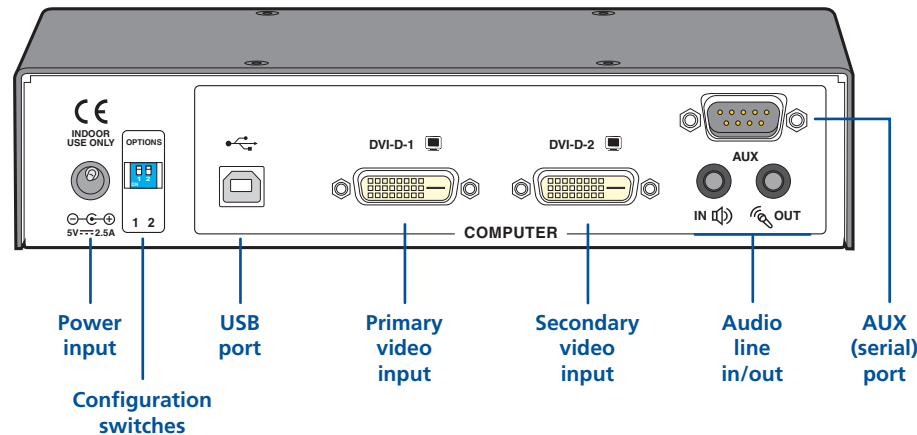

Power input

Configuration switches

USB port

Primary video input

Secondary video input

Audio line in/out

AUX (serial) port

ALIF2000R (receiver) - rear

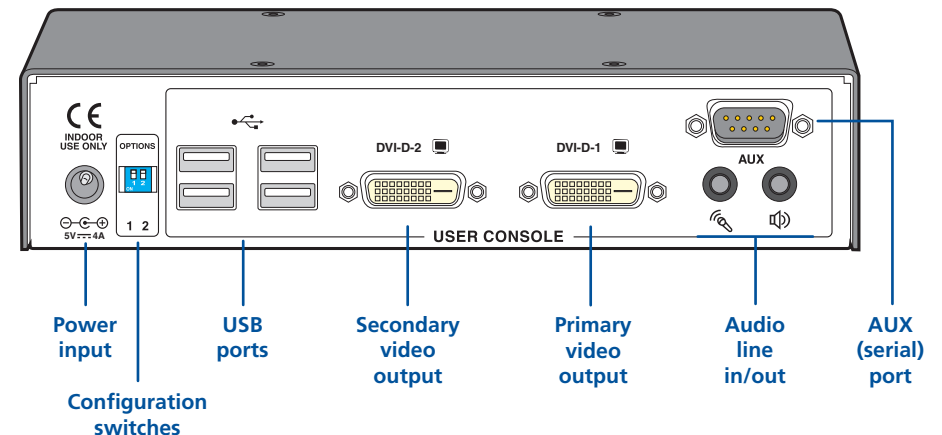

Power input

Configuration switches

USB ports

Secondary video output

Primary video output

Audio line in/out

AUX (serial) port

INSTALLATION

CONFIGURATION

OPERATION

FURTHER INFORMATION

INDEX

What's in the box (ALIF1000)



ALIF1000T package

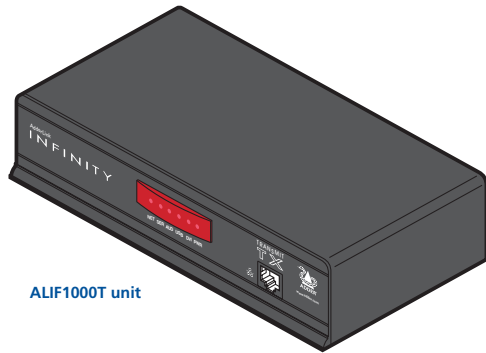

ALIF1000T unit

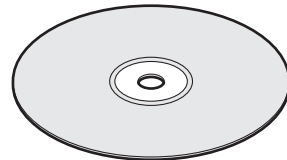

CD-ROM



Four self-adhesive rubber feet

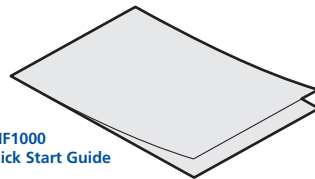

ALIF1000 Quick Start Guide

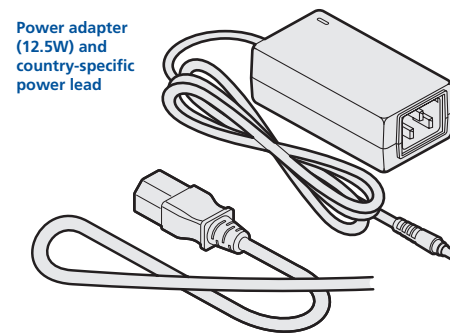

Power adapter (12.5W) and country-specific power lead

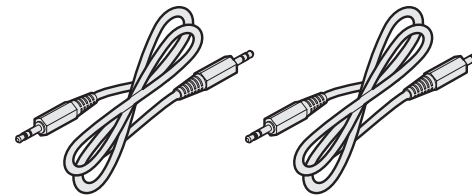

2 x Audio cable 2m (3.5mm stereo jacks)

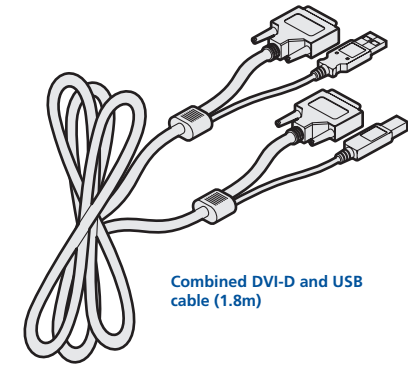

Combined DVI-D and USB cable (1.8m)

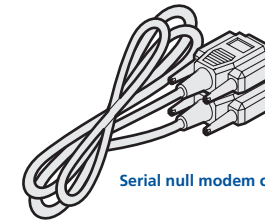

Serial null modem cable 2m

ALIF1000R package



ALIF1000R unit

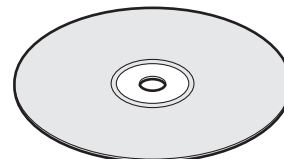

CD-ROM



Four self-adhesive rubber feet

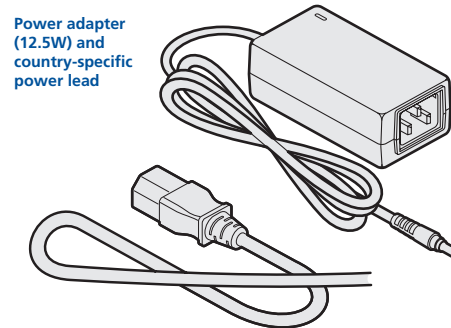

Power adapter (12.5W) and country-specific power lead

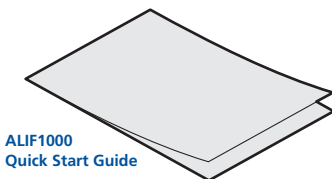

ALIF1000 Quick Start Guide

INSTALLATION

CONFIGURATION

OPERATION

FURTHER INFORMATION

INDEX

What's in the box (ALIF2000)



ALIF2000T package



ALIF2000T unit

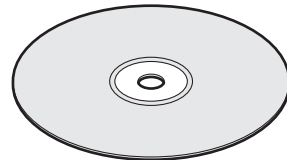

CD-ROM

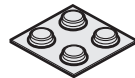

Four self-adhesive rubber feet

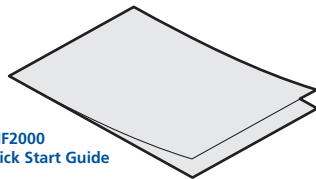

ALIF2000 Quick Start Guide

Power adapter (20W) and country-specific power lead

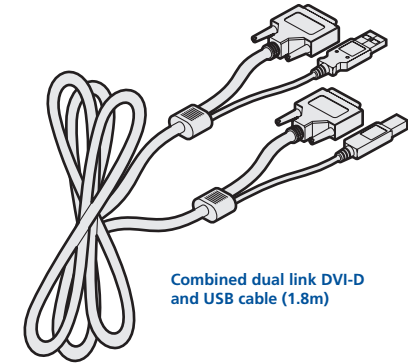
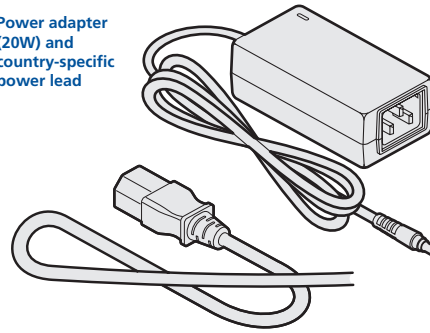

Combined dual link DVI-D and USB cable (1.8m)

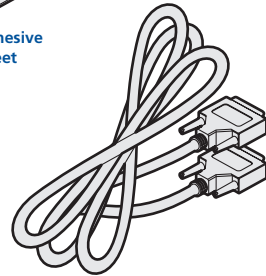

Single link DVI-D to DVI-D video cable

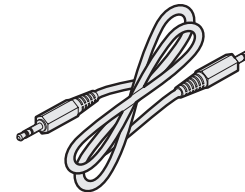

2 x Audio cable 2m (3.5mm stereo jacks)

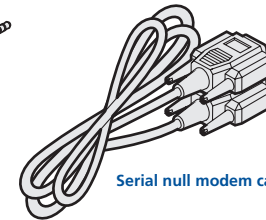
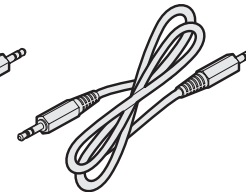

Serial null modem cable 2m

ALIF2000R package

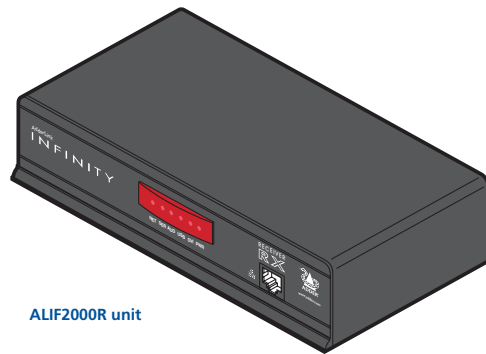

ALIF2000R unit

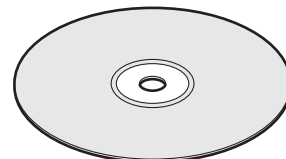

CD-ROM



Four self-adhesive rubber feet

Power adapter (20W) and country-specific power lead

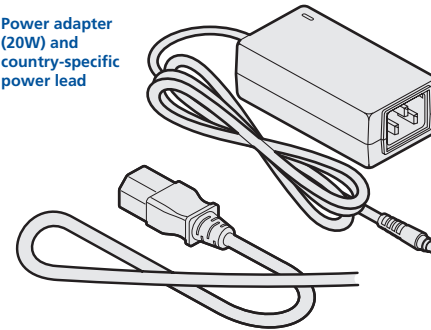

ALIF2000 Quick Start Guide

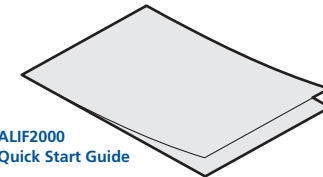

INSTALLATION

CONFIGURATION

OPERATION

FURTHER INFORMATION

INDEX

What you may additionally need

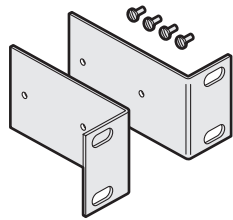

Two 19" rack-mount brackets and four screws
 Part numbers:
 One unit per 1U rack slot: RMK4S
 Two units per 1U rack slot: RMK4D

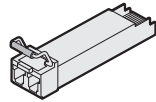

Fibre module (for ALIF2000)
 Part number: SFP-MM-LC

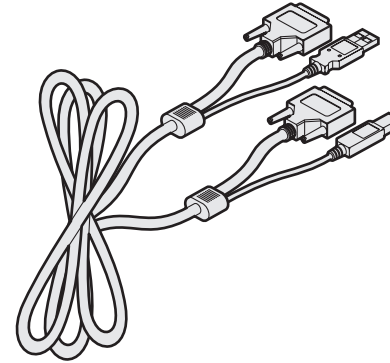

Combined dual link DVI-D and USB (USB type A to B) cable
 Part numbers: VSCD3 (1.8m length)
 VSCD4 (5m length)

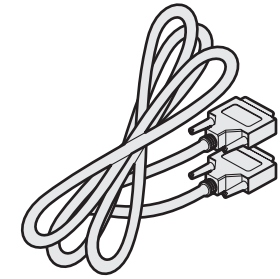

Single link DVI-D to DVI-D video cable
 Part number: VSCD1

Power adapter (12.5W) and country-specific power lead for ALIF1000 units
 Part number: PSU-IEC-5VDC-2.5A

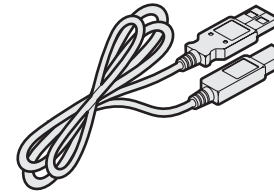
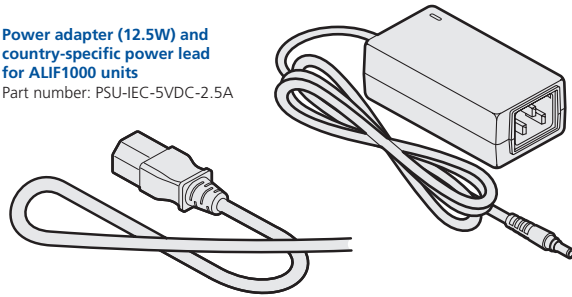

USB cable 2m (type A to B)
 Part number: VSC24

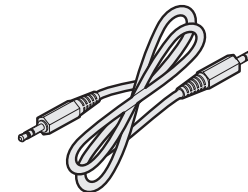

Audio cable 2m (3.5mm stereo jacks)
 Part number: VSC22

Power adapter (20W) and country-specific power lead for ALIF2000 units
 Part number: PSU-IEC-5VDC-4AMP

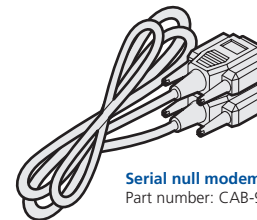
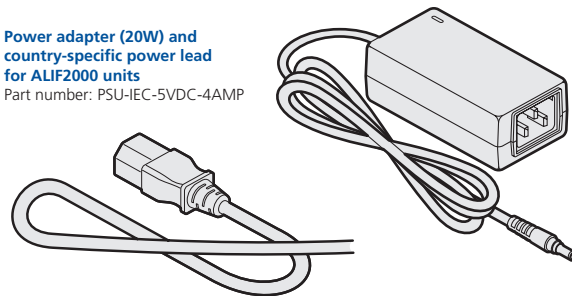

Serial null modem cable 2m
 Part number: CAB-9F/9F-NUL-MODEM

- INSTALLATION
- CONFIGURATION
- OPERATION
- FURTHER INFORMATION
- INDEX

Installation

Mounting

There are two main mounting methods for transmitter and receiver units:

- The supplied four self-adhesive rubber feet
- Optional rack brackets

Connections

Note: The ALIF units and their power supplies generate heat when in operation and will become warm to the touch. Do not enclose them or place them in locations where air cannot circulate to cool the equipment. Do not operate the equipment in ambient temperatures exceeding 40°C. Do not place the products in contact with equipment whose surface temperature exceeds 40°C.

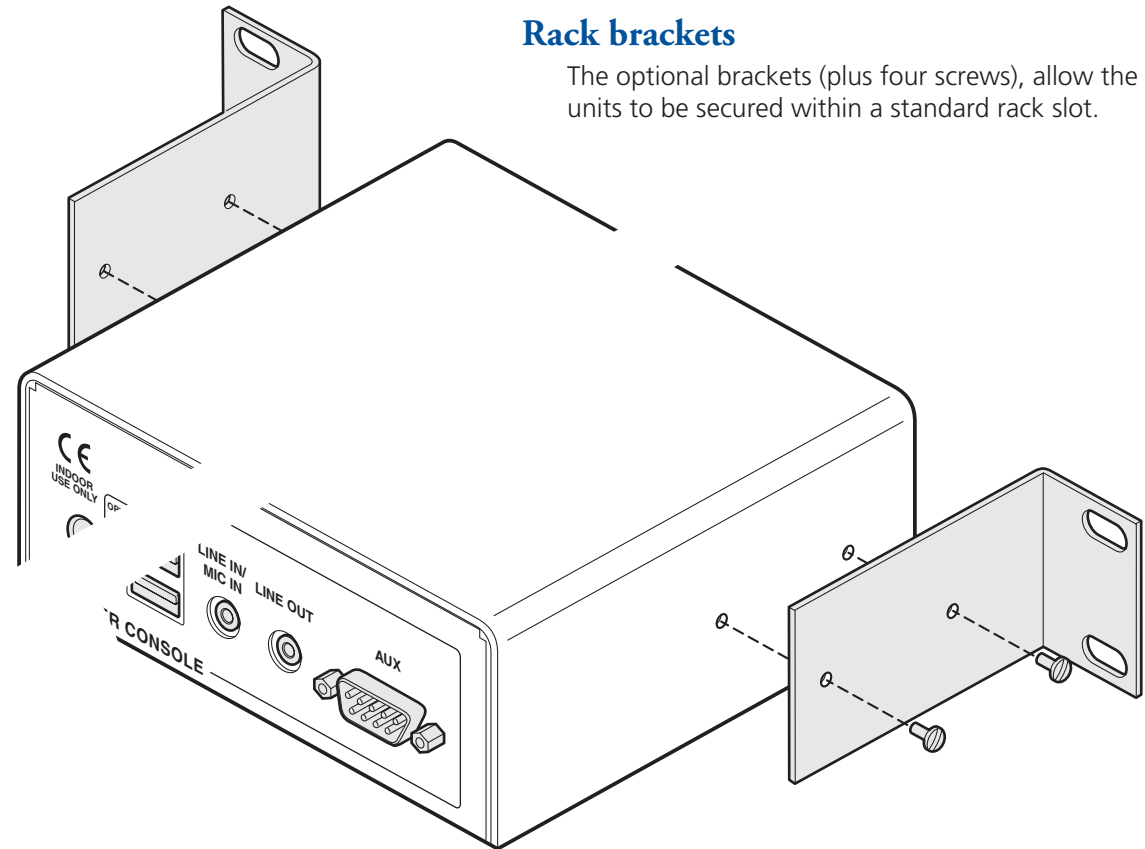

Rack brackets

The optional brackets (plus four screws), allow the units to be secured within a standard rack slot.

Connections

Installation involves linking the ALIF TX unit to various ports on the host computer, while the ALIF RX unit is attached to your peripherals:

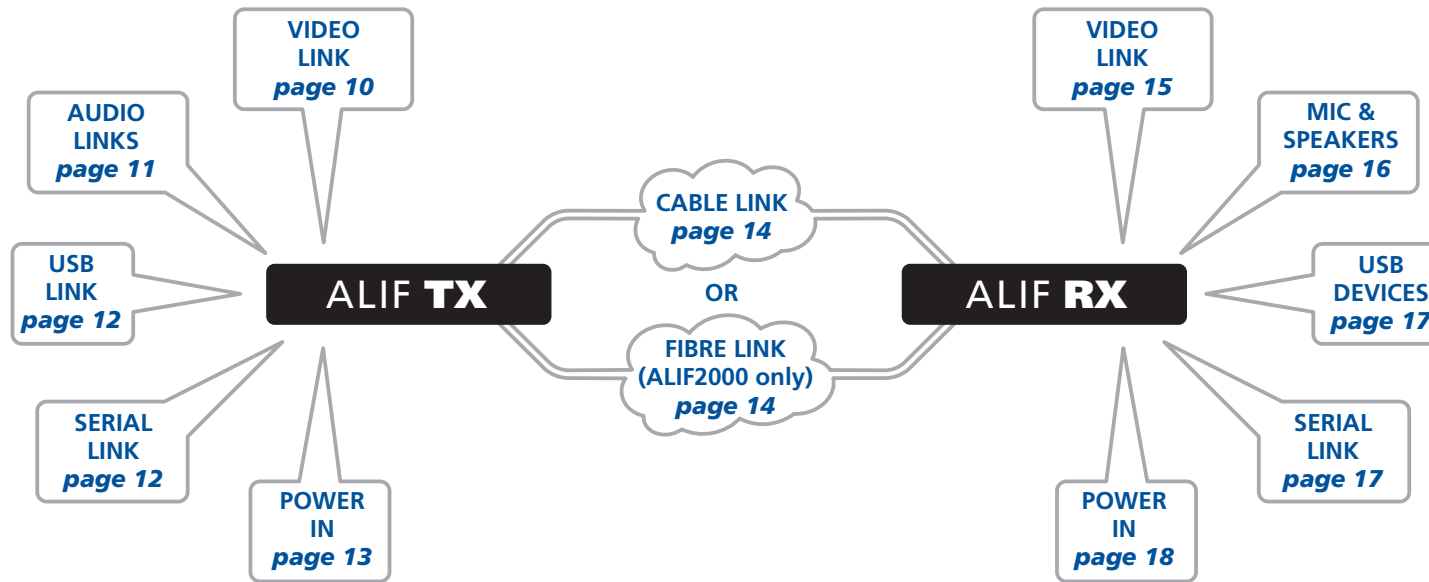

Click a connection to see details

- INSTALLATION
- CONFIGURATION
- OPERATION
- FURTHER INFORMATION
- INDEX

TX video link

ALIF units support DVI **digital** video signals and so use DVI-D video connectors throughout.

- ALIF1000 models can support a single high resolution DVI-D video display at pixel clocks up to 165MHz (equating to an example display mode of 1920 x 1200 at 60Hz refresh).
- ALIF2000 models can simultaneously support up to two Single Link high resolution video displays at pixel clocks up to 165MHz; or can alternatively support a single Dual Link very high Resolution video display at pixel clocks up to 330MHz (equating to an example display mode of 2560 x 1600 at 60 Hz refresh).

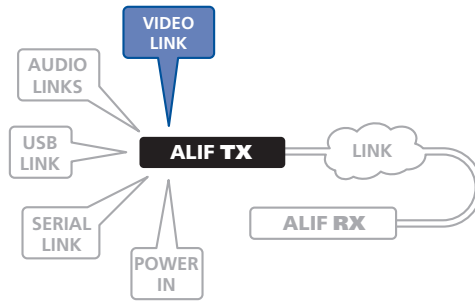

To make a video link

- 1 Wherever possible, ensure that power is disconnected from the ALIF and the host computer.
- 2 Connect a digital video link cable to the DVI-D socket (ALIF1000) or DVI-D-1 (ALIF2000) on the TX unit rear panel:

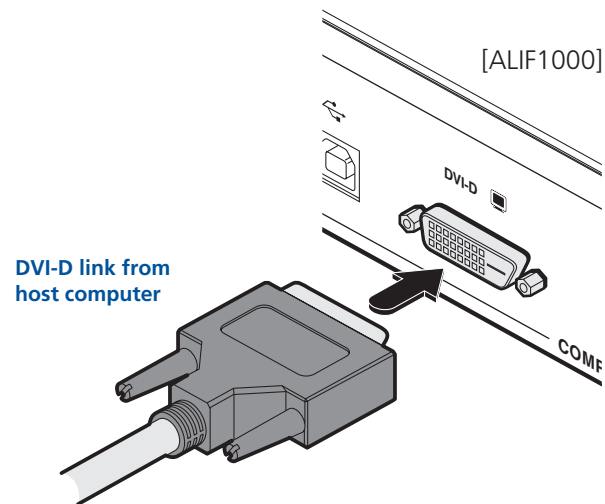

- 3 Connect the plug at the other end of the cable to the corresponding DVI-D video output socket of the host computer.

[ALIF2000 when using two single link DVI-D displays] Connect an additional video input from the secondary video port of the computer system using the supplied secondary DVI-D link cable.

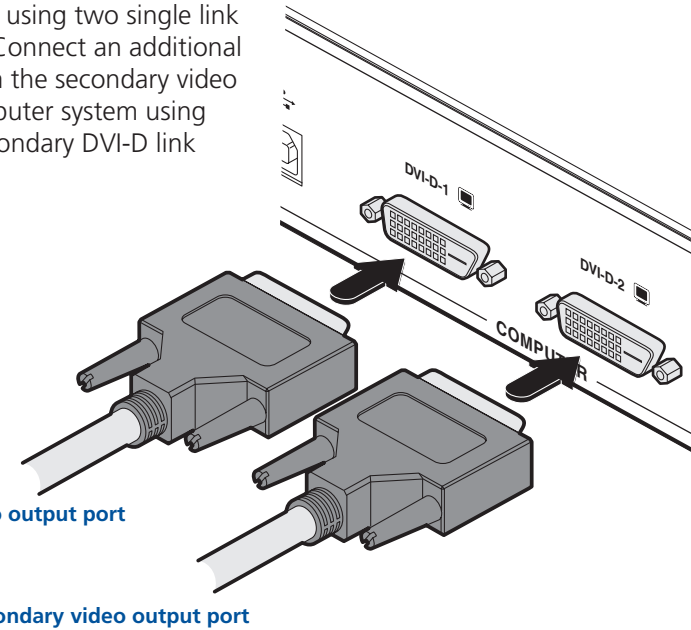

[ALIF2000 when using one very high resolution DVI-D dual link display] Use a DVI-D Dual Link cable (such as Adder part: VSCD3) to connect the primary video port of the computer system to the DVI-D-1 connector of the ALIF2000. A dual link cable must also be used at the RX unit.

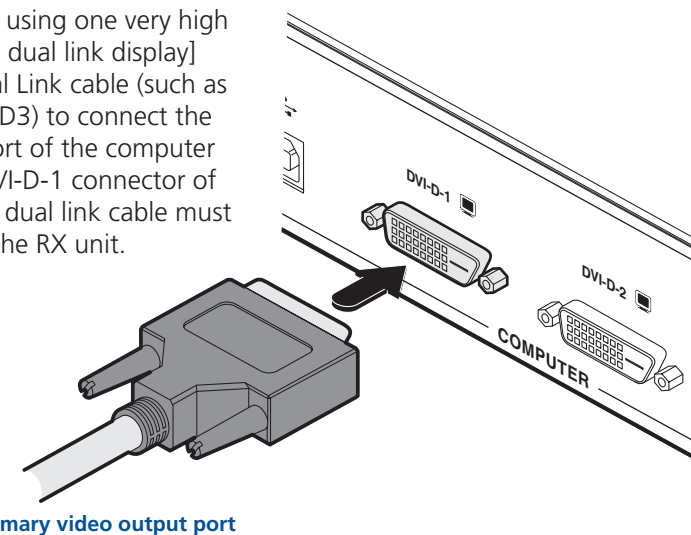

TX audio links

The ALIF units support two way stereo digital sound so that you can use a remote microphone as well as speakers.

To make audio links

- 1 Connect an audio link cable between the LINE OUT socket on the TX unit rear panel and the speaker output socket of the host computer.

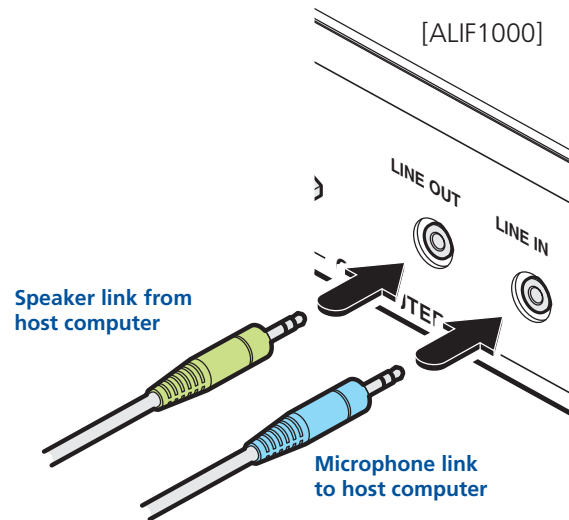

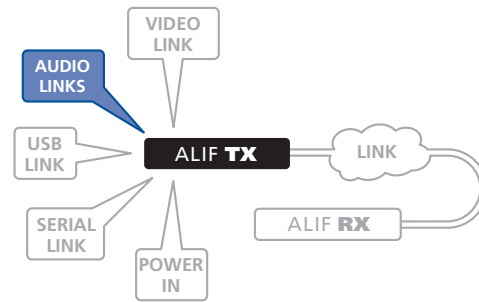

- 2 [Where a microphone is to be used]: Connect a second audio link cable between the LINE IN socket on the TX unit rear panel and the Line In socket of the host computer.

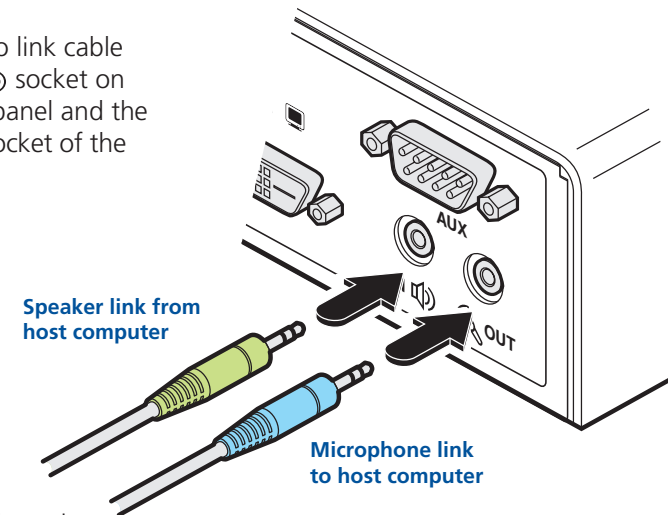

[ALIF2000]

- 1 Connect an audio link cable between the  socket on the TX unit rear panel and the speaker output socket of the host computer.



- 2 [Where a microphone is to be used]: Connect a second audio link cable between the  out socket on the TX unit rear panel and the Line In socket of the host computer.

TX USB link

ALIF units act as USB 2.0 hubs and so can provide four sockets at the RX unit with only a single connection at the TX unit.

To make a USB link

- 1 Connect the type B connector of the supplied USB cable to the USB port on the TX unit rear panel.

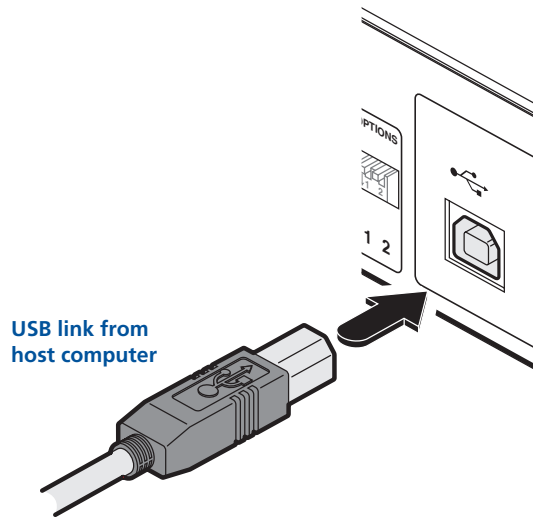
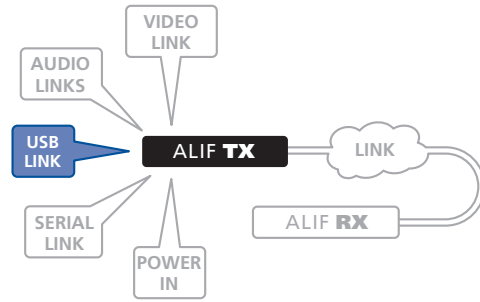

- 2 Connect the type A connector of the cable to a vacant USB socket on the host computer.

TX AUX port

The AUX port is an RS232 serial port that allows extension of RS232 signals up to a baud rate of 115200. The port has software flow control, but no hardware flow control.

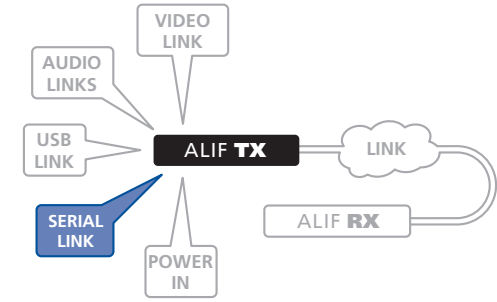

To connect the AUX port

- 1 Ensure that power is removed from the ALIF unit.
- 2 Connect a suitable serial 'null-modem' cable (see [Appendix](#) for pin-out) between a vacant serial port on your computer and the AUX port on the right hand side of the ALIF rear panel.

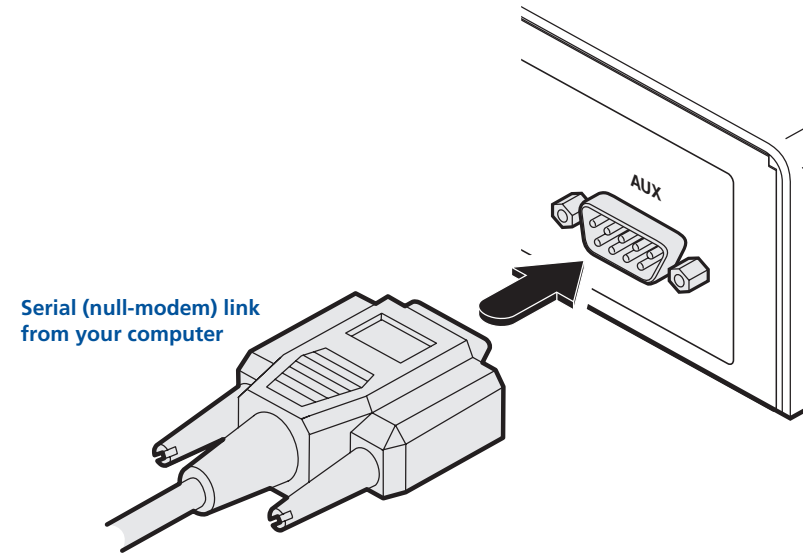

TX power in

Each ALIF unit is supplied with an appropriate power adapter. When all other connections have been made, connect and switch on the power adapter unit.

Note: Please see Power adapter identification shown opposite.

To apply power in

- 1 Attach the output lead from the power adapter to the 5V socket on the rear panel of the unit.
- 2 Connect the IEC connector of the supplied country-specific power lead to the socket of the power adapter.

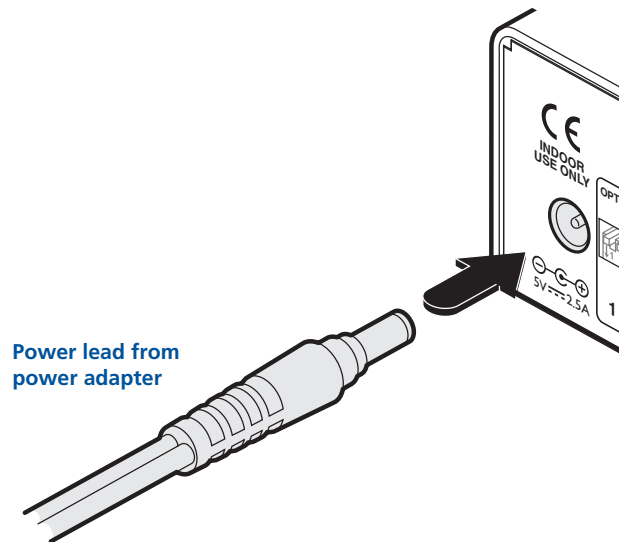

Note: Ensure that Option switches 1 and 2 are both in the 'off' (up) position to enable normal operation of the unit.

- 3 Connect the power lead to a nearby main supply socket.

Note: Both the unit and its power supply generate heat when in operation and will become warm to the touch. Do not enclose them or place them in locations where air cannot circulate to cool the equipment. Do not operate the equipment in ambient temperatures exceeding 40°C. Do not place the products in contact with equipment whose surface temperature exceeds 40°C.

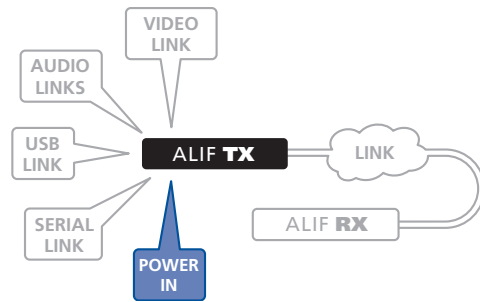

Power adapter identification

Due to the increased power requirements of the ALIF2000 series, these models are supplied with larger capacity (20W) power adapters. The standard 12.5W and higher power 20W adapters use identical housings, so within installations where both types are used, you need to double check the underside labels to differentiate the two types:

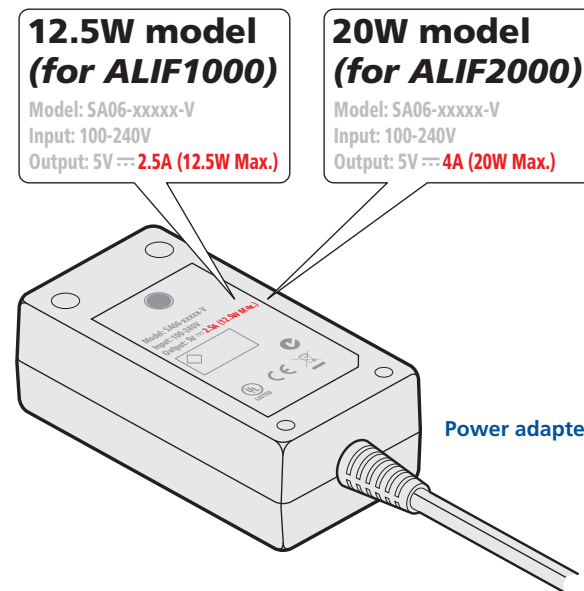

No damage will be caused if the 12.5W adapter and the 20W adapter are used in place of each other on either of the ALIF1000 or ALIF2000 units. However, correct operation of ALIF2000 units can only be guaranteed if a 20W power adapter is used. Always ensure that only ADDER 5-volt power supplies are used to power the units.

TX/RX network link

ALIF units can be either connected directly to each other or via a Gigabit Ethernet network. Additionally, ALIF2000 units can be networked by fibre optic links.

For direct links over Ethernet cable, the length of cable should not exceed 100 metres (328 feet). Network cables used for connections may be category 5, 5e, 6 or 7 twisted-pair cable. ALIF TX units have an autosensing capability on their network interfaces, so for direct point-to-point connections, no 'crossover' Ethernet cable is required.

For direct links over fibre optic links, either 50/125µm or 62.5/125µm MMF cables with duplex LC connectors are suitable for use with the recommended fibre module (Adder part number: SFP-MM-LC). Distances up to 500 metres are achievable with 50/125µm fibre and distances up to 300 metres with 62.5/125µm fibres. The fibre cable must be a crossover cable.

To link ALIF units using Gigabit Ethernet

- 1 Connect a CAT 5, 5e, 6, or 7 cable to the socket on the front panel of the ALIF unit.

CAT 5, 5e, 6, or 7 link either directly from the other ALIF unit or from a Gigabit Ethernet switch

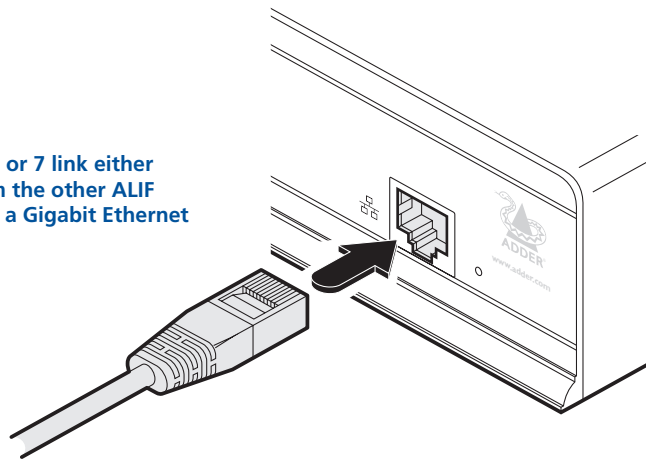

- 2 Connect the other end of the cable either to the other ALIF unit or to a Gigabit Ethernet switch, as appropriate.
- 3 [For connections via a network] repeat steps 1 and 2 for the other ALIF unit.

[ALIF2000] When making Gigabit Ethernet links



Reserved for future use

Use only the right hand port for Gigabit Ethernet links

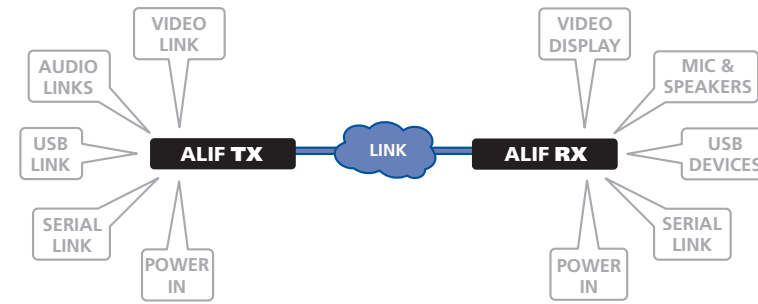

To link ALIF units using fibre optic links (ALIF2000 only)

- 1 Insert the optional fibre module (SFP-MM-LC) into the aperture on the ALIF2000 front panel:

Optional fibre module

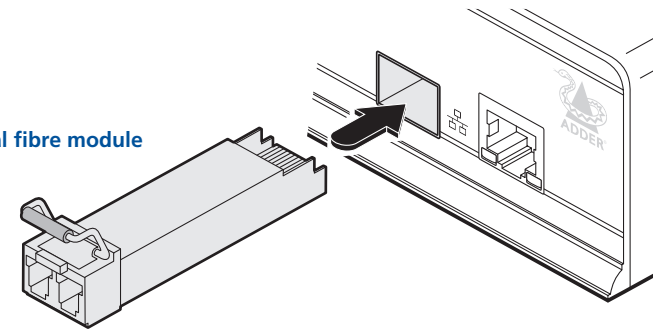

- 2 Connect the transmit and receive fibre links to the fibre module and close the latch over the link connectors to lock them into place.

Transmit and receive fibre links

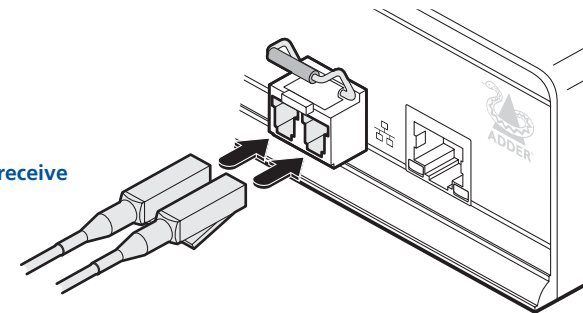

- 3 Connect the other end of the fibre links either to the other Infinity unit or to a Gigabit Ethernet switch, as appropriate.

RX video display

ALIF units support DVI **digital** video signals and so use DVI-D video connectors throughout.

- ALIF1000 models can support a single high resolution DVI-D video display at pixel clocks up to 165MHz (equating to an example display mode of 1920 x 1200 at 60Hz refresh).
- ALIF2000 models can simultaneously support up to two high resolution video displays at pixel clocks up to 165MHz; or can alternatively support one very high resolution video display (at pixel clocks up to 330MHz).

To connect a digital DVI video display

- 1 Connect the lead from the video display to the DVI-D socket on the rear panel of the ALIF unit.

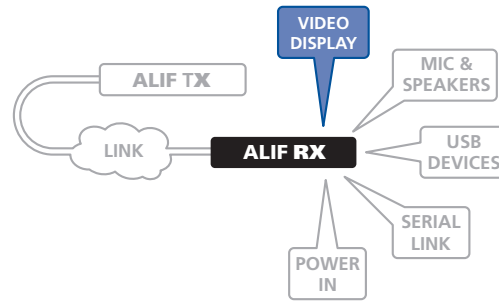
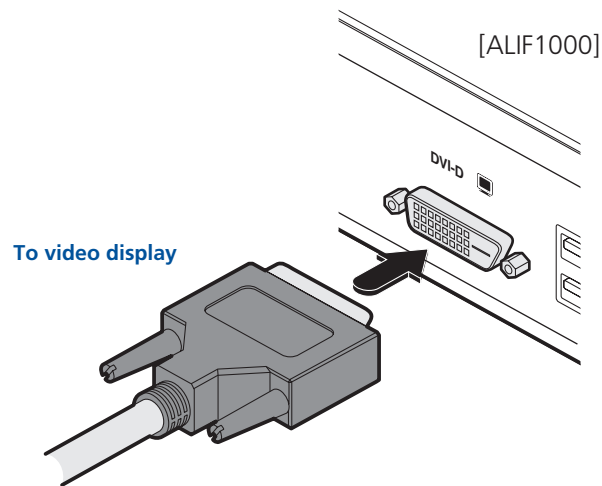

[ALIF2000 when using two single link DVI-D displays] Connect an additional video input from the secondary video port of the computer system using the supplied secondary DVI-D link cable.

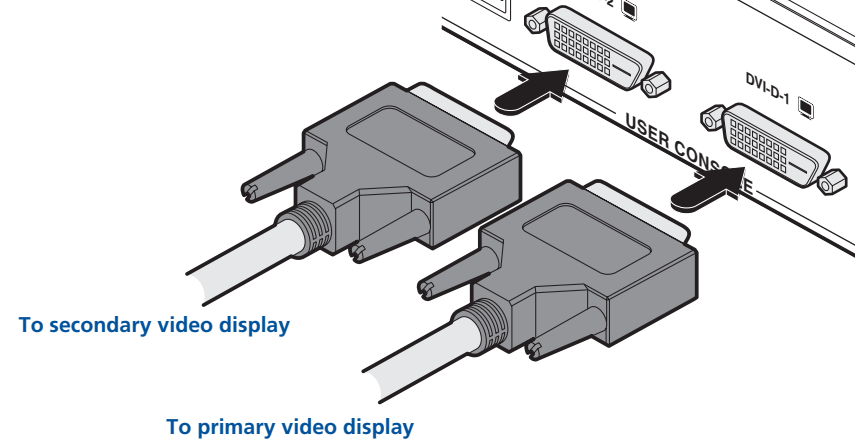

[ALIF2000 when using one very high resolution DVI-D dual link display] Use a DVI-D Dual Link cable (such as Adder part: VSCD3) to connect the video display to the DVI-D-1 connector of the ALIF2000 RX unit. A dual link cable must also be used at the TX unit.

When using dual link on DVI-D-1, the DVI-D-2 port will be disabled.
If DVI-D-2 is already being used, then it must be disconnected before dual link operation can occur on DVI-D-1.

VSCD3 cable to primary video display

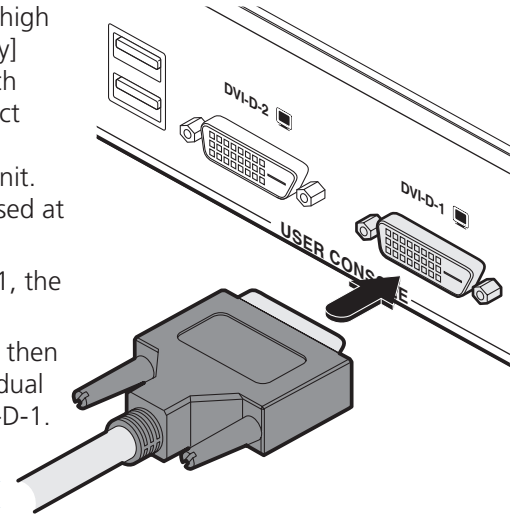

RX microphone & speakers

The ALIF unit can support a microphone as well as speakers providing the necessary connections have been made between the ALIF TX unit and the host computer.

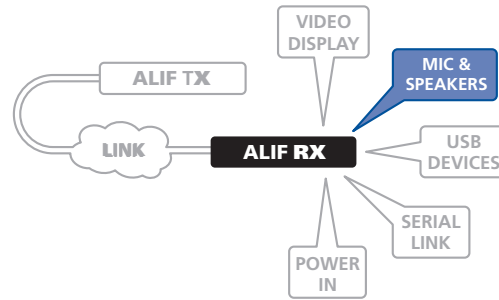

To connect a microphone (or line in) and/or speakers

- 1 Connect the lead from a mono microphone or, alternatively, a line in connection from an audio device to the 3.5mm socket labelled **LINE IN/MIC IN** on the rear panel.
- 2 Connect the lead from stereo speakers or, alternatively, a line out connection from an audio device to the 3.5mm socket labelled **LINE OUT** on the rear panel.

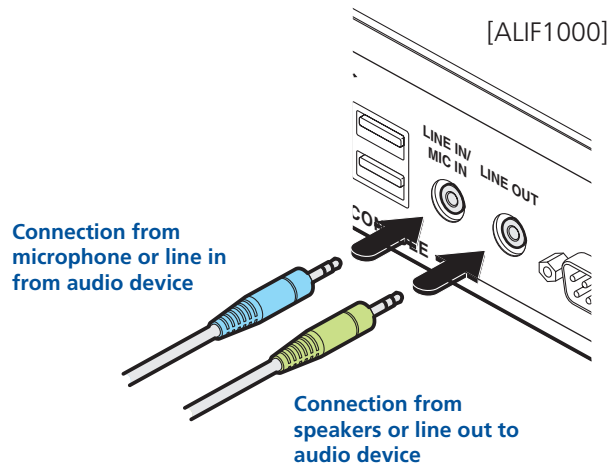

- 3 Once the unit has been fully connected and powered on, access the RX System Configuration page to check that the *Audio Input Type* setting matches the connection that you have made to the port: *line*, *mic* or *mic boost* (the latter provides +20dB gain).

[ALIF2000]

- 1 Connect the lead from a mono microphone to the 3.5mm socket labelled  on the rear panel.

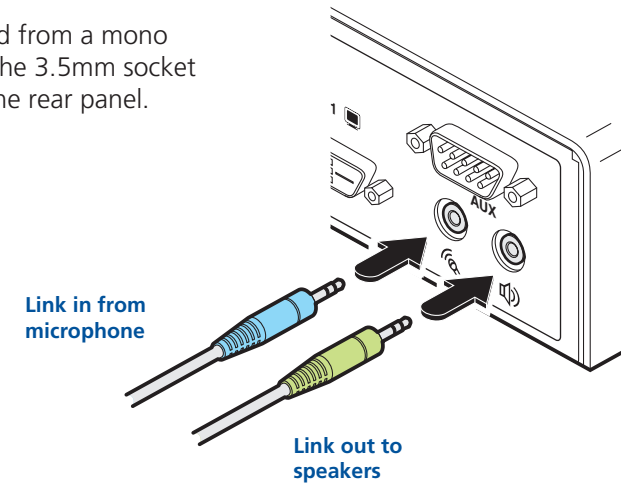

- 2 Connect the lead from stereo speakers to the 3.5mm socket labelled  on the rear panel.
- 3 Once the unit has been fully connected and powered on, access the RX System Configuration page to check that the *Audio Input Type* setting matches the connection that you have made to the port: *mic* or *mic boost* (the latter provides +20dB gain).

RX USB devices

The ALIF RX unit has four USB ports to which peripherals may be connected. The ports are interchangeable. To connect more than four peripherals, one or more USB hubs may be used. The total current that may be drawn from the USB ports is 1.2A, which should be sufficient for a keyboard, mouse (no more than 100mA each) and any two other devices (500mA maximum each). If more power for USB devices is required, use a powered USB hub.

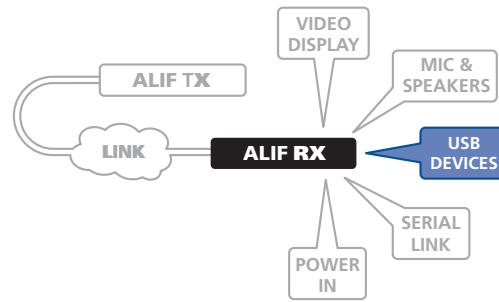

To connect a USB device

- 1 Connect the lead from the device to any of the four USB sockets on the rear panel of the ALIF unit.

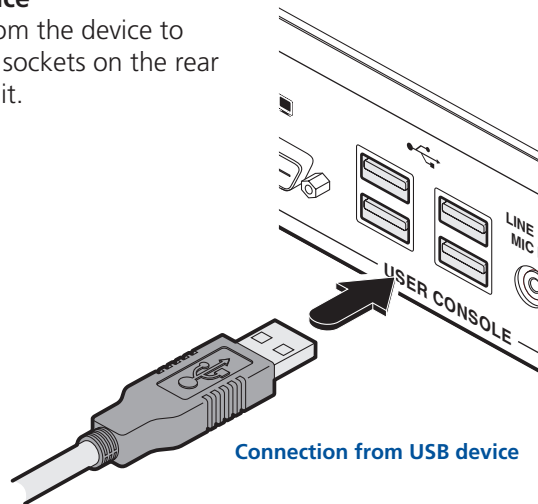

Supported USB Devices

USB devices are supported using True Emulation technology. This means that the signals of each USB peripheral are emulated to the computer so that full functionality is available, subject to the following limitations:

- Keyboards, mice and other HID devices are supported.
- Storage devices (i.e. flash drives, USB hard disks, CD-ROM drives) are supported, but they may operate more slowly than with a direct connection.
- Isochronous devices (including microphones, speakers, webcams and TV receivers) are not currently supported.
- Many other devices (such as printers, scanners, serial adapters and specialist USB devices) will work, but due to the huge variety of devices available, successful operation cannot be guaranteed.

RX AUX port

The AUX port is an RS232 serial port that allows extension of RS232 signals up to a baud rate of 115200. The port has software flow control, but no hardware flow control.

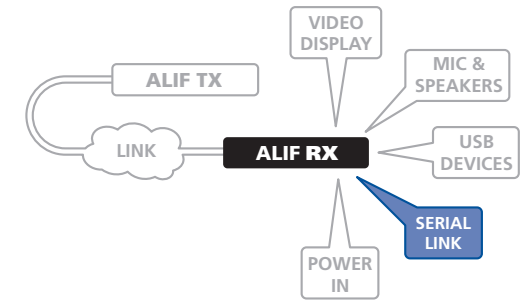

To connect the AUX port

- 1 Ensure that power is removed from the ALIF unit.
- 2 Connect a suitable serial 'null-modem' cable (see [Appendix](#) for pin-out) between the AUX port on the right hand side of the ALIF rear panel and your remote serial device.

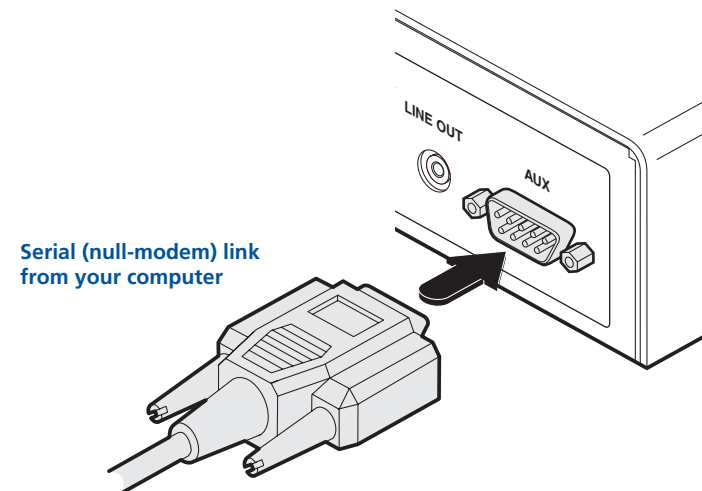

RX power in

Each ALIF unit is supplied with an appropriate power adapter. When all other connections have been made, connect and switch on the power adapter unit.

Note: Please see Power adapter identification shown opposite.

To apply power in

- 1 Attach the output lead from the power adapter to the 5V socket on the rear panel of the unit.
- 2 Connect the IEC connector of the supplied country-specific power lead to the socket of the power adapter.

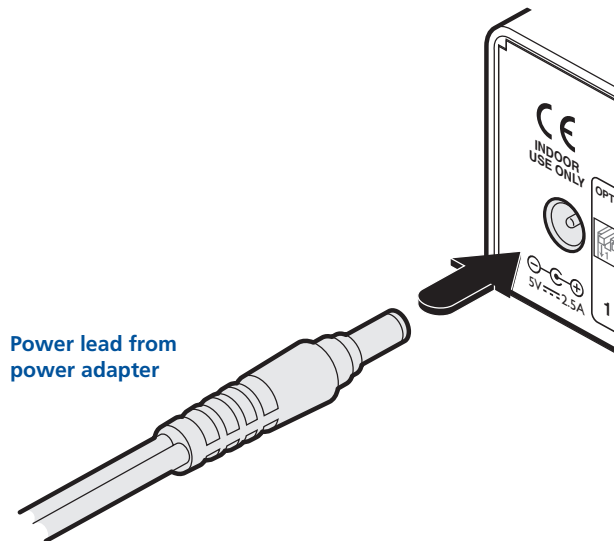

Note: Ensure that Option switches 1 and 2 are both in the 'off' (up) position to enable normal operation of the unit.

- 3 Connect the power lead to a nearby main supply socket.

Note: Both the unit and its power supply generate heat when in operation and will become warm to the touch. Do not enclose them or place them in locations where air cannot circulate to cool the equipment. Do not operate the equipment in ambient temperatures exceeding 40°C. Do not place the products in contact with equipment whose surface temperature exceeds 40°C.

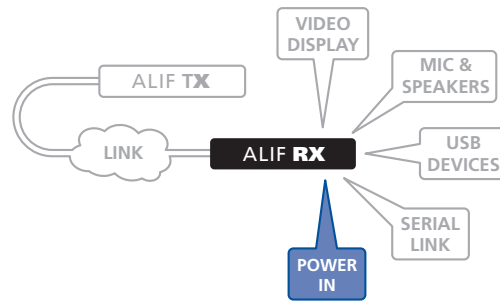

Power adapter identification

Due to the increased power requirements of the ALIF2000 series, these models are supplied with larger capacity (20W) power adapters. The standard 12.5W and higher power 20W adapters use identical housings, so within installations where both types are used, you need to double check the underside labels to differentiate the two types:

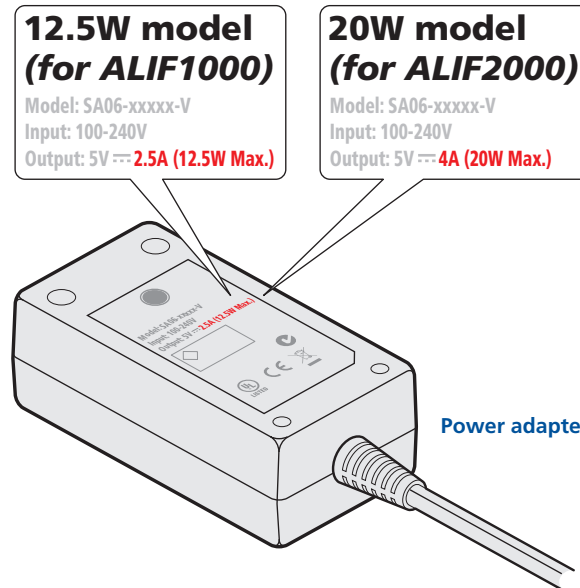

No damage will be caused if the 12.5W adapter and the 20W adapter are used in place of each other on either of the ALIF1000 or ALIF2000 units. However, correct operation of ALIF2000 units can only be guaranteed if a 20W power adapter is used. Always ensure that only ADDER 5-volt power supplies are used to power the units.

Configuration

Initial configuration

ALIF units are designed to be as flexible as possible, and this principle extends also to their configuration.

- Where an ALIF TX and an ALIF RX are directly linked to each other, no configuration action is required, provided that they have their factory default settings in place. If the standard settings have been changed in a previous installation, you merely need to perform a factory reset on each unit:
- Where ALIF units are connected via network links, you will need to specify their network address details. This can be done using a computer system temporarily linked to each ALIF unit via a network connection together with the [Infinity browser-based configuration utility](#). This configuration utility also allows numerous other settings to be altered.

Configuring network switches to ensure efficient operation

With IP Multicast there is a risk that network segments can get saturated with data that are not destined for any device on that segment. Unless some intelligence is applied, it's possible for a naive IP switch to pass multicast data onto every port on the switch. This can lead to performance degradation and wasted network bandwidth. Fortunately, however, modern switches employ a technique known as IGMP Snooping (Internet Group Management Protocol) which enables them to be selective about where they route multicast IP traffic - routing it only through switch ports which contain devices that are specifically interested in such traffic.

IGMP Snooping can significantly reduce the amount of traffic generated by ALIF TX units that are configured for multicast operation. It is beyond the scope of this document to detail how to enable and configure IGMP snooping for particular Gigabit IP Switches. However, we strongly recommend that when deploying an ALIF Network you should select IP switches that support IGMP snooping, and this snooping should be enabled and appropriately configured.

Manual factory reset

A factory reset returns an ALIF TX or RX unit to its default configuration. You can perform factory resets using either of the two configuration utilities or by using this direct manual method.

To perform a manual factory reset

- 1 Remove power from the ALIF unit.
- 2 Use a narrow implement (e.g. a straightened-out paper clip) press and hold the recessed reset button on the front panel. Power on the unit and then release the reset switch.

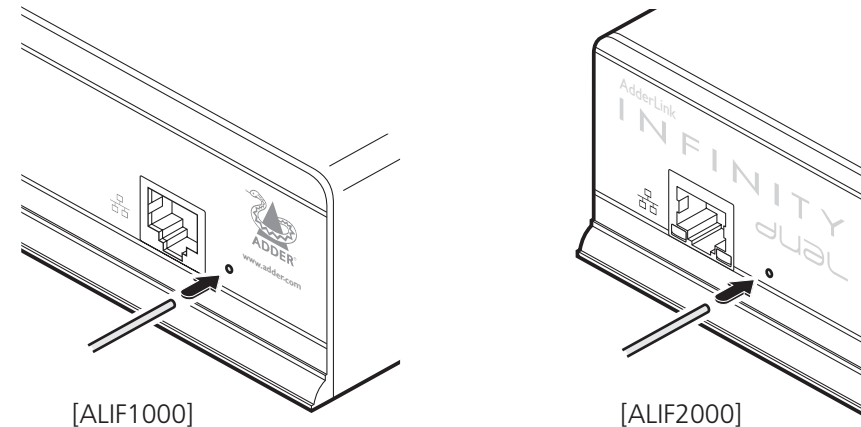

Use a straightened-out paper clip to press the reset button while powering on the unit

After roughly eight seconds, when the factory reset has completed, five of the front panel indicators will flash for a period of three seconds to indicate a successful reset operation.

- 3 Remove and then re-apply power to start the unit in its default configuration.

Infinity browser-based configuration utility

The browser-based configuration utility within all TX and RX units requires a network connection between the ALIF unit and a computer on the same network. The configuration utility allows you to perform all of the following functions:

- View/edit the IP network address and netmask,
- Configure separate IP network addresses for video, audio and USB,
- Configure multicast settings (on RX units),
- Configure video bandwidth settings (on TX units),
- View the current video output (on TX units),
- Perform a firmware upgrade,
- Perform a factory reset.

To connect a computer system for browser-based configuration

- 1 Connect a suitable network cable to the Ethernet port on the front panel of the ALIF unit.

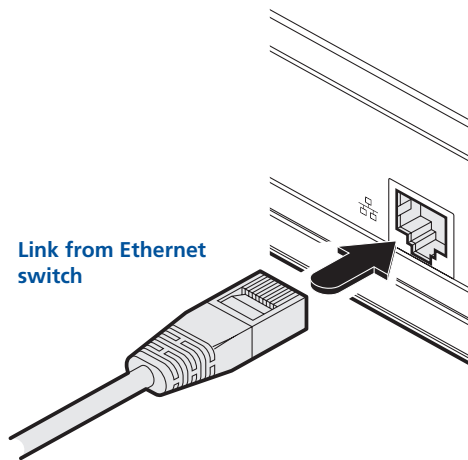

[ALIF2000] Note: Use the right hand Ethernet port.

- 2 Connect the other end of the link cable to your network.
- 3 Similarly, link your computer to the same network. *Note: A Gigabit connection is not essential for configuration purposes.*
- 4 If not already switched on, power up your computer and the ALIF unit. You are now ready to use the browser-based configuration utility.

To access the browser-based configuration utility

- 1 Temporarily connect the ALIF unit and a computer via a network, as discussed opposite.
- 2 Run a web browser on your computer and enter the IP address of the ALIF unit, e.g. <http://169.254.1.33>

The default settings are as follows:

- **TX units** - IP address: **169.254.1.33**
- **RX units** - IP address: **169.254.1.32**

Where the address of a unit is not known perform a [manual factory reset](#) to restore the default address.

The opening page of the ALIF configuration utility will be displayed and you can now use on-screen help for details of the functions that you wish to perform.



Performing an upgrade

ALIF units are flash upgradeable using the method outlined here. However, for larger installations we recommend that you use the AdderLink Infinity Manager (A.I.M) to upgrade multiple ALIF units. When using the method below, the ALIF unit will be upgraded in sequence.

Warning: During the upgrade process, ensure that power is not interrupted as this may leave the unit in an inoperable state.

To upgrade a single unit via network link

- 1 Download the latest upgrade file from the Adder Technology website.
Note: There are separate upgrade files for TX and RX units.
- 2 Temporarily connect the ALIF unit and a computer via a network (see [Infinity browser-based configuration utility](#) section for details).
- 3 Run a web browser on your computer and enter the IP address of the ALIF unit to be upgraded.
- 4 Click the Firmware Upgrade link. Within the Firmware Upgrade page, click the Choose File button. In the subsequent file dialog, locate the downloaded upgrade file - check that the file is correct for the unit being upgraded.
- 5 Click the Upgrade Now button. A progress bar will be displayed (however, if your screen is connected to the unit being upgraded then video may be interrupted) and the indicators on the front panel will flash while the upgrade is in progress.
- 6 The indicators should stop flashing in less than one minute, after which the unit will automatically reboot itself. The upgrade process is complete.



INSTALLATION

CONFIGURATION

OPERATION

FURTHER
INFORMATION

INDEX

Operation

In operation, many ALIF installations require no intervention once configured. The TX and RX units take care of all connection control behind the scenes so that you can continue to work unhindered.

Front panel indicators

The six front panel indicators on each unit provide a useful guide to operation:

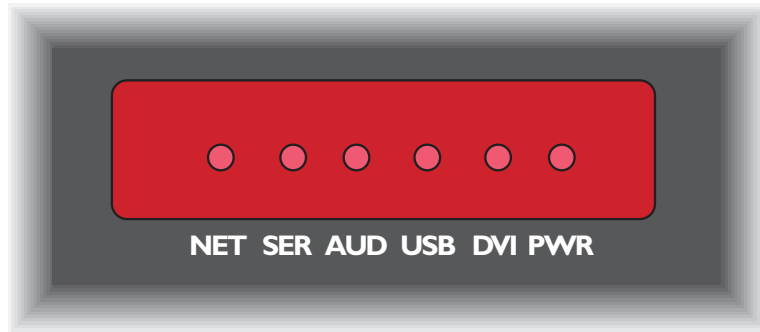

Indicators

These six indicators clearly show the key aspects of operation:

- **NET** On when valid network link is present. Flashes when the unit is in error.
- **SER** On when the AUX (serial) port is enabled and active.
- **AUD** On when audio is enabled and active.
- **USB** On when USB is enabled and active.
- **DVI** On when either or both DVI Video channels are enabled.
- **PWR** Power indicator.



INSTALLATION

CONFIGURATION

OPERATION

**FURTHER
INFORMATION**

INDEX

Appendix

RS232 'null-modem' cable pin-out

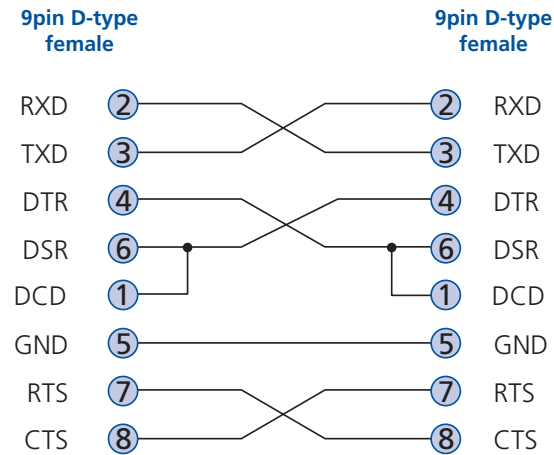

Supported video modes

ALIF units support all VESA and CEA video modes.

ALIF 1000 general specifications

Casing (w x h x d):	198mm (7.92") x 44mm (1.76") x 120mm (4.8")
Construction:	1U compact case, robust metal design
Weight:	0.75kg (1.65lbs)
Mount kits:	Rack mount - single or dual units per 1U slot. VESA monitor / wall mount chassis.
Power to adapter:	100-240VAC 50/60Hz, 0.5A,
Power to unit:	5VDC 12.5W
Operating temp:	0°C to 40°C (32°F to 104°F)
Approvals:	CE, FCC

ALIF 2000 general specifications

Casing (w x h x d):	198mm (7.92") x 44mm (1.76") x 120mm (4.8")
Construction:	1U compact case, robust metal design
Weight:	1.11kg (2.44lbs)
Mount kits:	Rack mount - single or dual units per 1U slot. VESA monitor / wall mount chassis.
Power to adapter:	100-240VAC 50/60Hz, 0.8A,
Power to unit:	5VDC 20W
Operating temp:	0°C to 40°C (32°F to 104°F)
Approvals:	CE, FCC



INSTALLATION

CONFIGURATION

OPERATION

FURTHER INFORMATION

INDEX

Warranty

Adder Technology Ltd warrants that this product shall be free from defects in workmanship and materials for a period of two years from the date of original purchase. If the product should fail to operate correctly in normal use during the warranty period, Adder will replace or repair it free of charge. No liability can be accepted for damage due to misuse or circumstances outside Adder's control. Also Adder will not be responsible for any loss, damage or injury arising directly or indirectly from the use of this product. Adder's total liability under the terms of this warranty shall in all circumstances be limited to the replacement value of this product.

If any difficulty is experienced in the installation or use of this product that you are unable to resolve, please contact your supplier.

Safety information

- For use in dry, oil free indoor environments only.
- Warning - live parts contained within power adapter.
- No user serviceable parts within power adapter - do not dismantle.
- Plug the power adapter into a socket outlet close to the module that it is powering.
- Replace the power adapter with a manufacturer approved type only.
- Do not use the power adapter if the power adapter case becomes damaged, cracked or broken or if you suspect that it is not operating properly.
- If you use a power extension cord with the units, make sure the total ampere rating of the devices plugged into the extension cord does not exceed the cord's ampere rating. Also, make sure that the total ampere rating of all the devices plugged into the wall outlet does not exceed the wall outlet's ampere rating.
- Do not attempt to service the units yourself.



INSTALLATION

CONFIGURATION

OPERATION

FURTHER
INFORMATION

INDEX

Radio Frequency Energy

A Category 5 (or better) twisted pair cable must be used to connect the units in order to maintain compliance with radio frequency energy emission regulations and ensure a suitably high level of immunity to electromagnetic disturbances.

All other interface cables used with this equipment must be shielded in order to maintain compliance with radio frequency energy emission regulations and ensure a suitably high level of immunity to electromagnetic disturbances.

European EMC directive 2004/108/EC

This equipment has been tested and found to comply with the limits for a class A computing device in accordance with the specifications in the European standard EN55022. These limits are designed to provide reasonable protection against harmful interference. This equipment generates, uses and can radiate radio frequency energy and if not installed and used in accordance with the instructions may cause harmful interference to radio or television reception. However, there is no guarantee that harmful interference will not occur in a particular installation. If this equipment does cause interference to radio or television reception, which can be determined by turning the equipment on and off, the user is encouraged to correct the interference with one or more of the following measures: (a) Reorient or relocate the receiving antenna. (b) Increase the separation between the equipment and the receiver. (c) Connect the equipment to an outlet on a circuit different from that to which the receiver is connected. (d) Consult the supplier or an experienced radio/TV technician for help.

FCC Compliance Statement (United States)

This equipment generates, uses and can radiate radio frequency energy and if not installed and used properly, that is, in strict accordance with the manufacturer's instructions, may cause interference to radio communication. It has been tested and found to comply with the limits for a class A computing device in accordance with the specifications in Subpart J of part 15 of FCC rules, which are designed to provide reasonable protection against such interference when the equipment is operated in a commercial environment. Operation of this equipment in a residential area may cause interference, in which case the user at his own expense will be required to take whatever measures may be necessary to correct the interference. Changes or modifications not expressly approved by the manufacturer could void the user's authority to operate the equipment.

Canadian Department of Communications RFI statement

This equipment does not exceed the class A limits for radio noise emissions from digital apparatus set out in the radio interference regulations of the Canadian Department of Communications.

Le présent appareil numérique n'émet pas de bruits radioélectriques dépassant les limites applicables aux appareils numériques de la classe A prescrites dans le règlement sur le brouillage radioélectriques publié par le ministère des Communications du Canada.



INSTALLATION

CONFIGURATION

OPERATION

FURTHER
INFORMATION

INDEX

INSTALLATION

CONFIGURATION

OPERATION

**FURTHER
INFORMATION**

INDEX

Index



- A**
 - Assistance 23
- B**
 - Bracket
 - rack mount 8
 - Brackets
 - fitting 8
 - Browser-based utility 20
- C**
 - Cable spec
 - null modem 24
 - Configuration
 - browser-based utility 20
 - styles 2
 - Connections
 - network link 14
 - overview 9
 - RX audio 16
 - RX AUX port 17
 - RX power in 18
 - RX USB devices 17
 - RX video display 15
 - TX audio links 11
 - TX AUX port 12
 - TX power in 13
 - TX USB link 12
 - TX video link 10
 - Connectors
 - overview 3
- D**
 - Dimensions 24
- F**
 - Factory reset 19
 - Firmware
 - upgrade 21
 - Front panel 3
 - Front panel indicators 22
- G**
 - Getting assistance 23
- I**
 - IGMP 19
 - Indicators 3,22
 - Initial configuration 19
- M**
 - Manual factory reset 19
- N**
 - Null-modem cable
 - pin-out 24
- P**
 - Parts
 - optional 7
 - supplied 5,6
- R**
 - Rack mounting 8
 - Rear panel 3
 - Reset
 - manual 19
- S**
 - Safety information 25
 - Specifications 24
 - Switch
 - IGMP configuration 19
- T**
 - Troubleshooting 23
- U**
 - Upgrade
 - firmware 21
- V**
 - Video modes 24
- W**
 - Warranty 25
 - Weight 24

INSTALLATION

CONFIGURATION

OPERATION

FURTHER INFORMATION

INDEX