

Internal Use Only
7610.483.42a/050938

INSTRUCTION MANUAL

Models: HGE 75 through HGE 500



Contents

GENERAL SAFETY INFORMATION 2

RECEIVING, MOVING, AND UNPACKING 2

INSTALLATION 3

INSTRUMENTATION 4

AUTOMATIC DRAIN VALVE (ADV) 4

START-UP 5

SHUTDOWN 5

MAINTENANCE 5

FIELD SERVICE GUIDE 7

ENGINEERING DATA 8

ELECTRICAL SCHEMATICS 9-10

AIR & REFRIGERANT FLOW SCHEMATICS 11-12

REPLACEMENT PARTS 13

WARRANTY 16

HGE SERIES

REFRIGERATED

COMPRESSED

AIR DRYERS

GENERAL SAFETY INFORMATION

1. PRESSURIZED DEVICES:

This equipment is a pressure containing device.



- Do not exceed maximum operating pressure as shown on equipment serial number tag.
- Make sure equipment is depressurized before working on or disassembling it for service.

2. ELECTRICAL:

This equipment requires electricity to operate.



- Install equipment in compliance with all applicable electrical codes.
- Standard equipment is supplied with electrical enclosures not intended for installation in hazardous environments.
- Disconnect power supply to equipment when performing any electrical service work.

3. BREATHING AIR:

Air treated by this equipment may not be suitable for breathing without further purification.



- Refer to applicable standards and specifications for the requirements for breathing quality air.

RECEIVING, MOVING, AND UNPACKING

A. RECEIVING

This shipment has been thoroughly checked, packed and inspected before leaving our plant. It was received in good condition by the carrier and was so acknowledged.

Check for Visible Loss or Damage. If this shipment shows evidence of loss or damage at time of delivery to you, insist that a notation of this loss or damage be made on the delivery receipt by the carrier's agent.

B. UNPACKING

Check for Concealed Loss or Damage. When a shipment has been delivered to you in apparent good order, but concealed damage is found upon unpacking, notify the carrier immediately and insist on his agent inspecting the shipment. Concealed damage claims are not our responsibility as our terms are F.O.B. point of shipment.

C. MOVING

In moving or transporting dryer, do not tip dryer onto its side.

D. STORAGE/SHUT DOWN

IMPORTANT: Do not store dryer in temperatures above 130°F (54.4°C).

INSTALLATION

Ambient Air Temperature

Locate the dryer indoors where the ambient air temperature will be between 45°F and 110°F. Intermittent operation at ambient temperatures up to 113°F will not damage the dryer but may result in a higher dew point or dryer shutdown due to high refrigerant discharge pressure (see Field Service Guide).

Do not operate air-cooled dryers at ambient air temperatures below 45°F. Such operation may result in low suction pressure, causing freeze-up.

Location and Clearance

Mount the dryer on a level base. If the base vibrates, bolt the unit down using vibration dampners. If the dryer is air cooled, install it in a clean, well-ventilated area to reduce fouling of the condenser coils with dirt and dust. Allow 24 inches clearance on the sides and the front of the dryer for cooling airflow and for service access.

System Arrangement

Liquid water adversely affects dryer performance. To prevent “slugging” the dryer with liquid water, locate the dryer downstream of an aftercooler and a mechanical separator. Install drain valves to discharge condensate that collects in these areas.

If the compressed airflow is relatively constant and does not exceed the dryer flow rating, it is recommended that the dryer be located downstream of the receiver tank. If the nature of the application is such that the air demand regularly exceeds the dryer flow rating, it is recommended that the dryer be located upstream of the receiver.

For safety and convenience, install inlet and outlet shutoff valves and depressurization valves. These valves allow the dryer to be isolated and depressurized for servicing. Bypass piping may be installed around the dryer for uninterrupted airflow when the dryer is serviced. If the compressed air operation cannot tolerate undried air for short periods, install a second dryer in the bypass line.

Compressed air systems commonly require filters to remove compressor oils, particulates, condensed liquids and other contaminants. When an oil-removal filter is used, it should be installed downstream of the refrigerated dryer. At this location, the life of the replaceable filter element is prolonged since some of the entrained oil is removed by the dryer and drained through the separator.

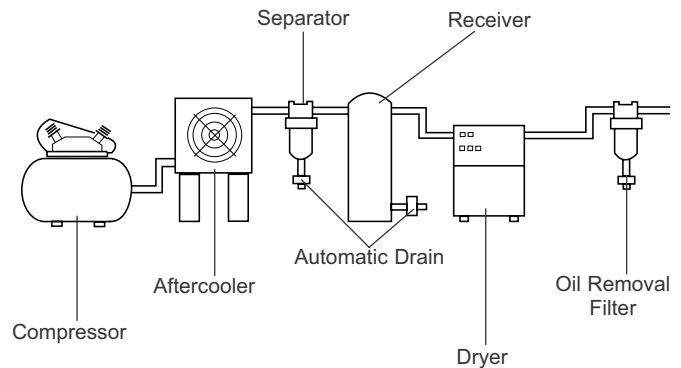

TYPICAL COMPRESSED AIR SYSTEM

Piping and Connections

Piping must be furnished by the user unless otherwise specified. Connections and fittings must be rated for the maximum operating pressure given on the dryer data plate and must be in accordance with applicable codes. Support all piping; do not allow the weight of any piping to stress the dryer or filter connections. Inlet and outlet shutoff valves and a valved bypass are recommended. Piping should be at least the size of the inlet and outlet connections to minimize pressure drop in the air system. See Engineering Data section for dryer inlet and outlet connection sizes.

Drains

Condensate must be drained from the dryer to prevent its re-entrainment. The dryers are equipped with automatic drain valves and internal drain hoses up to the drain connections on the dryer cabinets. The user must install a discharge line from the drain connection and run it to a waste disposal collection system that meets applicable regulations. Pipe or copper tubing 1/2 inch or larger is recommended for condensate discharge lines. Install the drain lines so that condensate can be seen as it drains.

Electrical Connections

The dryers are constructed according to NEMA Type 1 electrical standards. Field wiring must comply with local and national fire, safety and electrical codes. Installation must be in accordance with the National Electrical Code. Confirm that your line voltage is the same as the voltage listed on the dryer data plate. Refer to Figure 1 for electrical schematics.

⚠ CAUTION Operation of dryers with improper line voltage constitutes abuse and could affect the dryer warranty.

INSTRUMENTATION

ON/OFF Switch

The dryer is equipped with an ON/OFF switch on the front panel. A light signals when the dryer is on.

Dew Point Indicator (75 through 150 scfm models)

All dryers are equipped with a dew point indicator which indicates dryer conditions as follows:

It is normal for the dew point indicator to be in the red zone when the dryer is first turned on and then move to the green zone when the dryer reaches its normal operating temperature. If this indicator is in the red zone during normal operation, turn the dryer off to avoid compressor damage. Refer to the Field Service Guide, for additional information, or call your local distributor.

Dryer System Monitor (DSM) (200 through 500 scfm models)

The Dryer System Monitor (DSM) has LED type dew point temperature indicators and electronic drain valve timing controls. When the dryer is running normally, the green LEDs will illuminate. If the red LED is illuminated, there is a need for the dryer's operating condition to be checked.

NOTE: When the dryer is turned on, all LEDs will be illuminated. Allow 15 minutes for the red and yellow LEDs to be extinguished.

The automatic drain valve controls allow the period of drain opening to be set from 0.5 seconds to 9 seconds and drain valve closed time to be set from 0.5 minutes to 9 minutes. When the "PUSH TO TEST" button is pushed, the drain valve opens and remains open for the adjusted "open" time.

AUTOMATIC DRAIN VALVE (ADV)

All models are equipped with an electronic drain valve that automatically discharges condensate from the dryer. Drain valve operation is controlled by a drain valve timer. The drain opening can be set from 0.5 seconds to 9 seconds. The drain cycle can be set from 0.5 minutes to 9 minutes.

Models 75 through 150 have the timer mounted directly on the drain valve. For models 200 through 500, drain valve adjustments are made on the Dryer System Monitor (DSM).

Electronic Drain Valve Adjustment

To minimize air losses, the drain valve control time should be adjusted to open the drain port just long enough to discharge accumulated condensate. Set the drain valve operating time so that only air discharges at the end of the open period. Recommended initial settings are a 1 to 2-second drain opening and 30 seconds drain closed time. If liquid still discharges as the port is closing, set the timer for a shorter cycle or a longer opening.



DRYER SYSTEM MONITOR

START-UP

Follow the procedure below to start your dryer. Failure to follow the prescribed start-up procedure will invalidate the warranty. If problems arise during start-up, call your distributor.

Refer to Serial Number Tag for dryer operating capacity. Do not exceed recommended capacity.

1. Turn the dryer ON/OFF switch to OFF.
2. Check that the main electrical supply voltage matches the voltage specified on the dryer data plate.
3. Turn on the main electrical power to the dryer.
4. Check proper connection and support of compressed air lines to the dryer; check bypass valve system, if installed.
5. SLOWLY pressurize the dryer. The outlet valves of the dryer should be closed to prevent flow through the dryer.
6. Ensure adequate ventilation for air-cooled dryers.

To start dryer :

1. Turn the power switch to ON. The refrigerant compressor will turn on.
2. Allow the dryer to run 15 minutes. Confirm that the temperature indicators are in the green zone.
3. SLOWLY open the dryer outlet valves permitting flow through the dryer.
4. Confirm that condensate is discharging from the drain valve by pressing the "PUSH-TO-TEST" button.
5. Check drain valve timing. See Automatic Drain Valve section for drain valve adjustment procedure.
6. Confirm that the inlet air temperature, pressure and airflow to the to the dryer meet the specified requirements (see Engineering Data section)
7. Confirm that the condensate lines from the drain valve discharge into a collection tank or an environmentally-approved disposal system.

The dryer is designed to run continuously. Let the dryer run even when the demand for compressed air is interrupted; the dryer will not freeze up.

SHUTDOWN

When the dryer must be shut down for maintenance or other reasons, use the following procedures.

If electrical repairs must be made:

1. Turn off the power switch.
2. Disconnect the main power supply.
3. Lock out and tag the power supply in accordance with OSHA requirements.

▲WARNING Portions of the control circuit remain energized when the power switch is in the OFF position. Disconnect supply power to the dryer before performing maintenance on the electrical system.

Dismantling or working on any component of the compressed air system under pressure may cause equipment failure and serious personal injury. Before dismantling any part of the dryer or compressed air system, completely vent the internal pressure to the atmosphere.

MAINTENANCE

The dryers require little maintenance for satisfactory operation. Good performance can be expected if the following routine maintenance steps are taken.

▲WARNING Dismantling or working on any component of the compressed air system under pressure may cause equipment failure and serious personal injury. Before dismantling any part of the dryer or compressed air system, completely vent the internal pressure to the atmosphere.

General

For continued good performance of your refrigerated dryer, all refrigeration system maintenance should be performed by a competent refrigeration mechanic. Before corrective maintenance is done during the warranty period, call your local distributor and proceed according to instructions.

Daily

Check the operation of the automatic drain valve at least once daily. See the Field Service Guide for remedies to drain valve malfunctions. See the AUTOMATIC DRAIN VALVE section for drain valve adjustment.

Weekly

Inspect the ambient air filter weekly and clean it if necessary. Dirty air filters cause loss of efficiency and may result in damage to the product.

Air Filter – Clean accumulated dust and dirt from air filter weekly or as required.

- A. Open ambient filter side door.
- B. Remove air filter by sliding upwards.
- C. Wash with soap and water and allow to dry before reinstalling.
Note: Do not use solvents to clean air filter.
- D. Reinstall air filter and right side door.
- E. If the filter is damaged, replace it with a new filter. Contact your distributor.

▲ CAUTION Do not operate the dryer without the ambient air filter. Permanent condenser damage may result.

Monthly

For air-cooled condensers, it is recommended to inspect the condenser coils monthly. If necessary, remove dirt or other particles with compressed air from an OSHA-approved air nozzle that limits its discharge pressure to 30 psig (2.1 kgf/cm²).

Returns to Manufacturer

If the dryer or a component of the dryer must be returned to the manufacturer, first call your local distributor for a return authorization number and shipping address. Your distributor will inform you whether the dryer or only a component must be returned. Mark the package with the return authorization number and ship freight prepaid as directed by your local distributor.

Automatic Drain Valve Disassembly and Servicing

The valve body is mounted on the frame bottom; a fitting connects the valve body to the heat exchanger vessel.

▲ CAUTION Do not disassemble drain valve timer or attempt to repair electrical parts. Replace timer if defective.

The drain valve discharges condensate through a full-port drain opening. The valve body may need to be cleaned under conditions of gross particulate contamination.

To disassemble the drain valve body for cleaning and other maintenance:

1. Turn power switch off.
2. Disconnect main power supply to dryer.
3. Lock out and tag power supply in accordance with OSHA requirements.

▲ WARNING If power supply is not disconnected before disassembly, serious personal injury and valve damage may result.

4. Remove hoses that connect the drain valve to the drain valve strainer.
5. Remove screw and washer from front of the drain valve.
6. Remove the power supply connector and gasket (with the timer assembly if attached) from the solenoid coil housing. Do not damage or lose the gasket.
7. Remove coil fixing nut and spring washer from top of solenoid coil housing.
8. Lift solenoid coil housing off solenoid core in valve body.
9. Unscrew solenoid core from valve body.

Once the drain valve is disassembled, the following maintenance can be performed.

1. Inspect internal parts of valve body; clean or replace as required.
2. Remove debris from valve body.
3. Wipe solenoid core components with a clean cloth or blow out debris with compressed air from an OSHA-approved air nozzle that limits its discharge pressure to 2.1 kgf/cm².
4. Check that the inside part assembly is clear and solenoid coil moves freely in housing.
5. If timer is attached to valve body, check electrical continuity across timer assembly.

To reassemble the drain valve, reverse the sequence of the preceding steps. After the drain valve is reassembled, connect the main power supply to the dryer.

When the dryer is returned to service, check the drain valve for air or condensate leaks; tighten connections as required to correct leaks. Check the drain cycle; adjust the timer according to the procedure in the drain valve adjustment section.

FIELD SERVICE GUIDE

Problems most frequently encountered with refrigerated dryers are water downstream of the dryer and excessive pressure drop. Most causes can be identified and remedied by following this guide.

⚠ WARNING Closed refrigeration systems are potentially dangerous. Work on the refrigeration system must be done only by a competent licensed refrigeration mechanic. Do not release fluorocarbon refrigerants to the atmosphere. Do not discharge liquid refrigerants into floor drains. Refrigerant vapors may accumulate in low places. Inhalation of high concentrations may be fatal. Do not

smoke while working on the refrigeration system or when a refrigerant leak is suspected. Burning materials may decompose refrigerants, forming toxic gas or acids that may cause serious injury and property damage.

PROBLEM	SYMPTOM	POSSIBLE CAUSE	REMEDY
Water downstream of dryer	Refrigerant compressor not running.	Loss of power to dryer.	Check power supply, fuses and/or breakers. Check for loose connections.
		Dryer turned off.	Check On/Off switch position.
		Dryer overloaded.	Confirm that inlet flow, inlet temperature and inlet pressure are within acceptable range of dryer.
		Condenser clogged with debris.	Check/clean ambient air filter and condenser.
		Fan motor inoperative.	Check fan motor operation. Replace if necessary.
		Ambient temperature too high.	Verify ambient temperatures throughout the day.
		High pressure switch activated (models 200 to 500 only)	Press manual reset button to switch to reset button.
		Compressor overheated.	Turn dryer off. Contact local distributor.
		Compressor defective.	Turn dryer off. Contact local distributor.
	No condensate discharging from dryer.	Drain strainer clogged.	Clean drain strainer.
		Drain valve inoperative.	Check/rebuild drain valve.
		Drain timer or DSM inoperative.	Confirm there is power to the timer or DSM. Replace timer or DSM, if necessary.
		Drain solenoid inoperative.	Confirm there is power to the coil. Replace coil, if necessary.
	Condensate discharging from dryer.	Incorrect drain timer setting.	Adjust drain timer - increase open time and/or decrease closed time.
Liquid water entering dryer.	Aftercooler drain valve malfunction.	Check, repair aftercooler drain valve.	
Excessive pressure drop across dryer	Frozen condensate in evaporator.	Incorrect hot gas bypass valve setting.	Contact local distributor.
	Inlet air pressure low.	Upstream restriction in air system.	Check all upstream air system components (valves, regulators, etc.)
	Dryer undersized.	Excessive compressed air flow.	Resize dryer.
Dew Point indicator out of green zone.	Dew Point indicator out of green zone.	Dryer overloaded.	Confirm that inlet flow, inlet temperature and inlet pressure are within acceptable range of dryer.
		Condenser clogged with debris.	Check/clean ambient air filter and condenser.
		Loose sensor connection.	Confirm gauge or DSM sensor is tightly connected to dryer tubing.
		Defective gauge, DSM or DSM sensor.	Replace gauge, DSM or DSM sensor.

ENGINEERING DATA

Model	75	100	125	150	200	250	300	400	500
Specifications									
Rated Capacity ^a - (scfm)	75	100	125	150	200	250	300	400	500
Inlet/Outlet Connections - (inches)	3/4	1	1	1	1-1/2	1-1/2	1-1/2	2	2
Dimensions									
Height - (inches)	20.1	20.6	20.6	20.6	30.0	30.0	29.9	29.9	31.5
Length - (inches)	19.7	28.3	28.3	28.3	35.4	35.4	37.4	37.4	41.3
Width - (inches)	18.9	13	13	13	16.1	16.1	19.3	19.3	23.2
Power Supply - (V/Ph/Hz)	115/1/60	115/1/60	115/1/60	115/1/60	460/3/60	460/3/60	460/3/60	460/3/60	460/3/60
Refrigerant Compressor Capacity ^c - (BTU/hr)	3,414	3,953	3,953	5,406	8,787	13,969	13,969	17,574	22,151
Input Power - (kW)	0.72	0.74	0.76	1.11	1.42	1.98	2.05	2.50	3.06
Refrigerant Type ^b	R-134a	R-134a	R-134a	R-134a	R-134a	R-134a	R-134a	R-134a	R-134a

^a Rating conditions are 100°F inlet temperature, 100 psig inlet pressure, 100% inlet relative humidity, 100°F ambient temperature @ 60Hz.

^b Refer to dryer data plate for refrigerant charge.

^c Compressor capacity @ 35°F evaporating temperature, 130°F condensing temperature.

MINIMUM - MAXIMUM OPERATING CONDITIONS	ALL MODELS
Min. - Max. Inlet Air Pressure (compressed air at inlet to dryer)	10 - 232 psig
Min. - Max. Inlet Air Temperature (compressed air at inlet to dryer)	40°F - 120°F
Min. - Max. Ambient Temperature	45°F - 110°F

Note: Continuous operation in the above maximum and minimum operation conditions is not allowable.

Suction Pressure

REFRIGERANT	WITHOUT AIRFLOW
R-134a	31 psig

Refrigerant Pressure Switch Settings

Model 75 to 500

Fan Cycle Control	
Fan Pressure Switch Setting	
R-134a	
Cut-In	Cut-Out
199 psig	142 psig

Models 200 to 500

Refrigerant Compressor Control		
High Pressure Switch Setting		
Sensor Location	R-134a	
	Cut-out	Cut-in
Compressor Discharge	298 psig Manual Reset	201 psig

ELECTRICAL SCHEMATICS

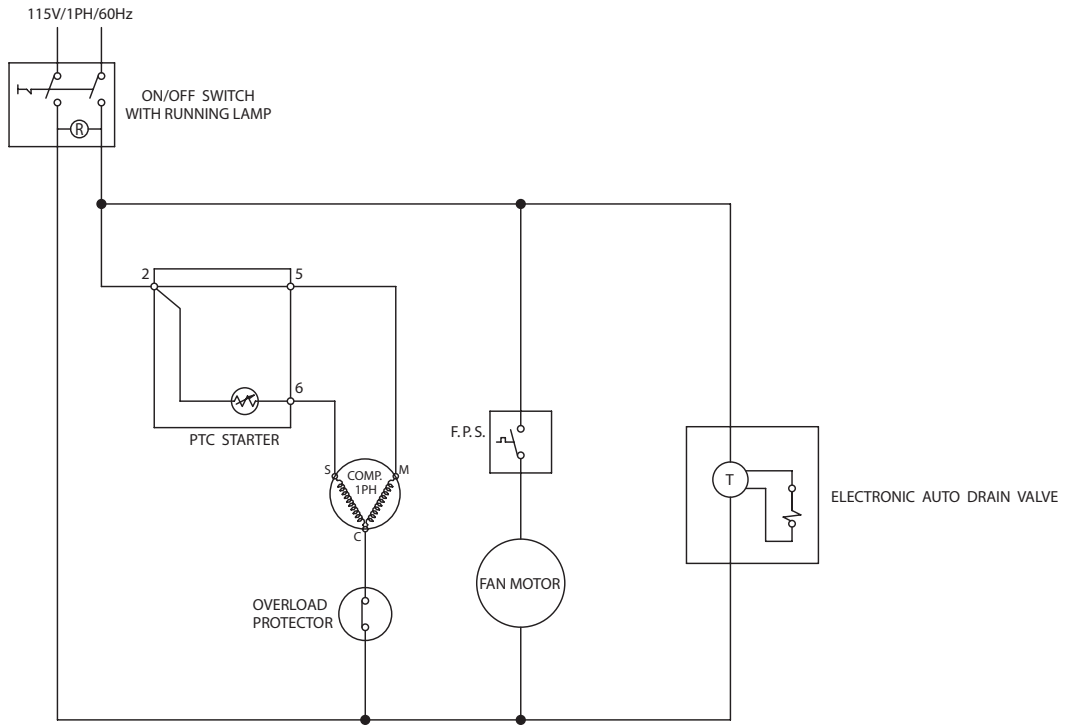

Figure 1a
75 scfm model

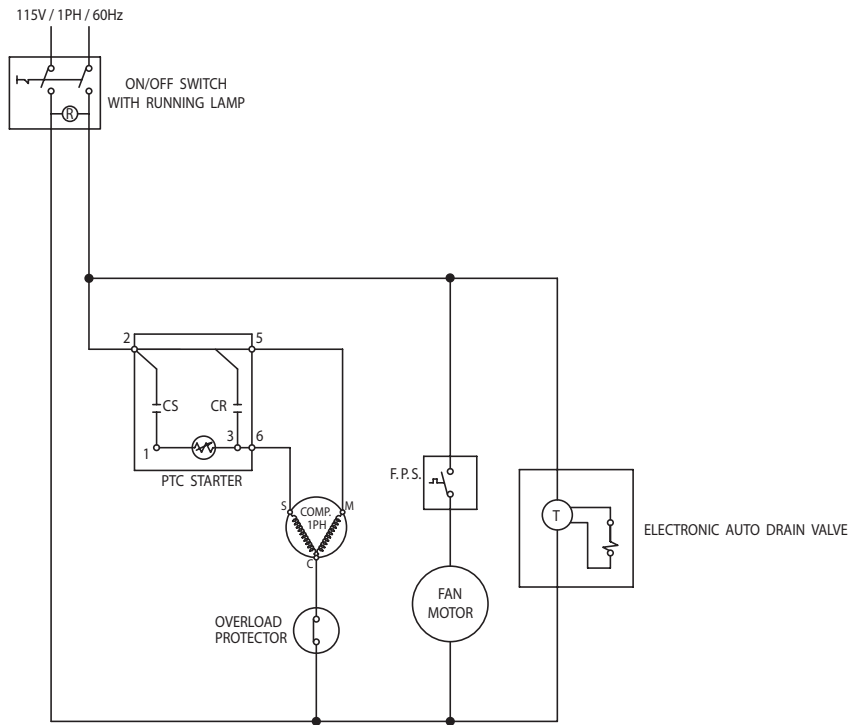

Figure 1b
100 to 125 scfm model

ELECTRICAL SCHEMATICS

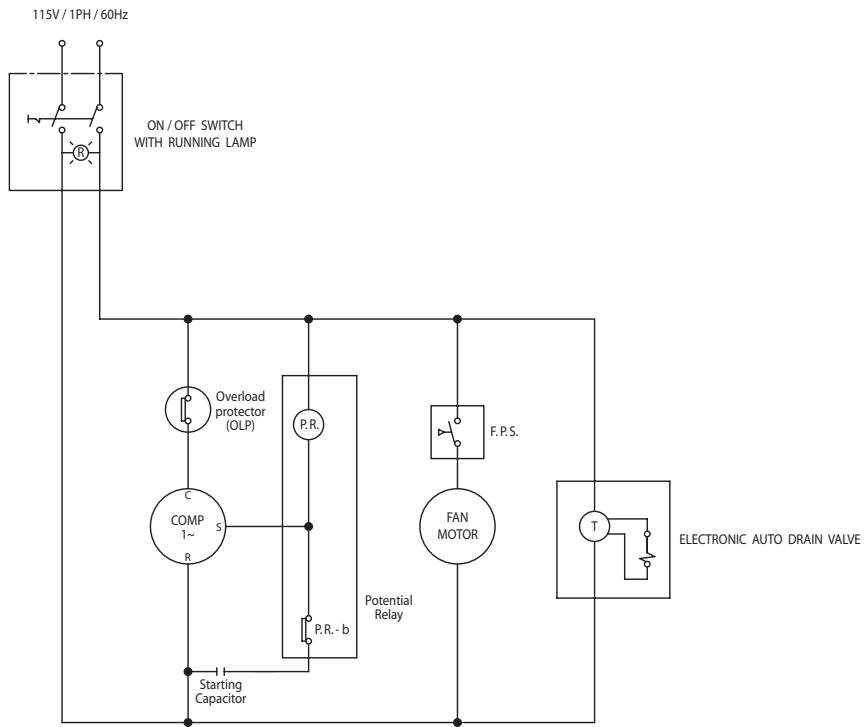

Figure 1c
150 scfm model

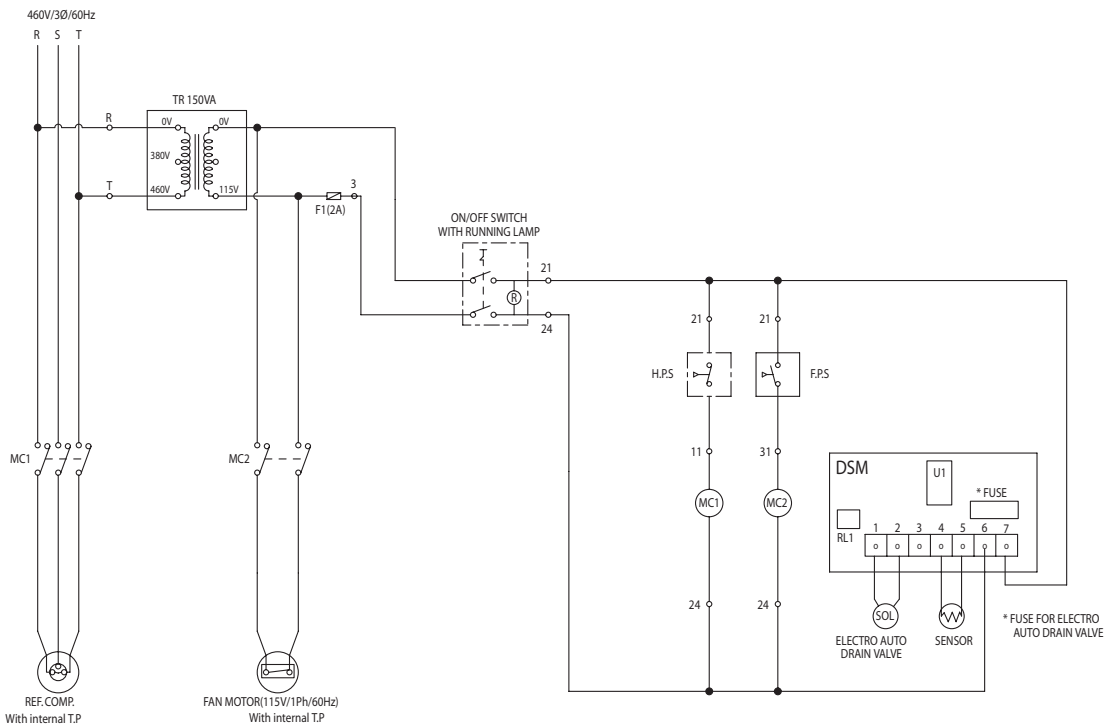

Figure 1d
200 to 500 scfm model

AIR & REFRIGERANT FLOW SCHEMATICS

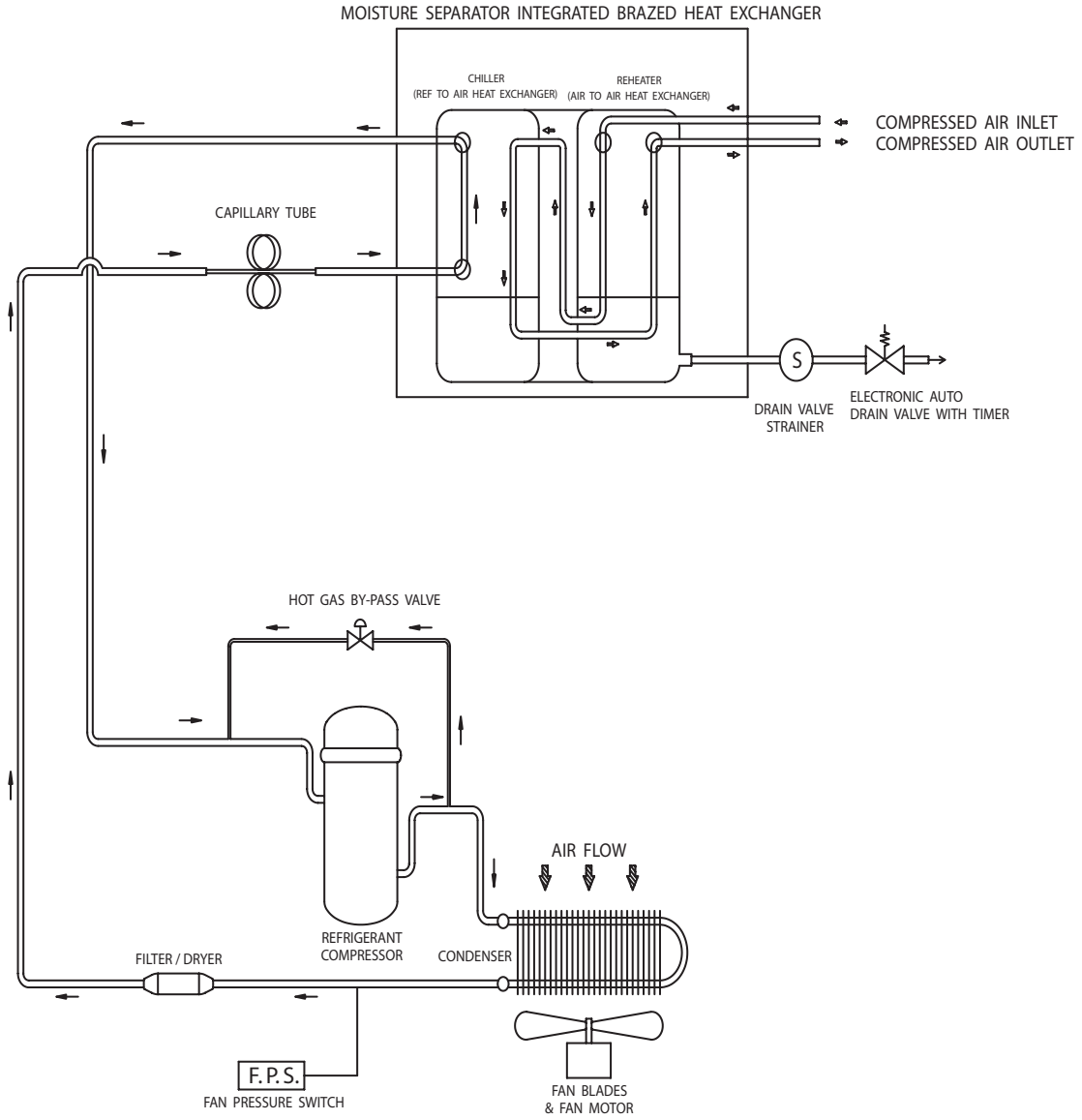

Figure 2a
75 - 150 scfm model

AIR & REFRIGERANT FLOW SCHEMATICS

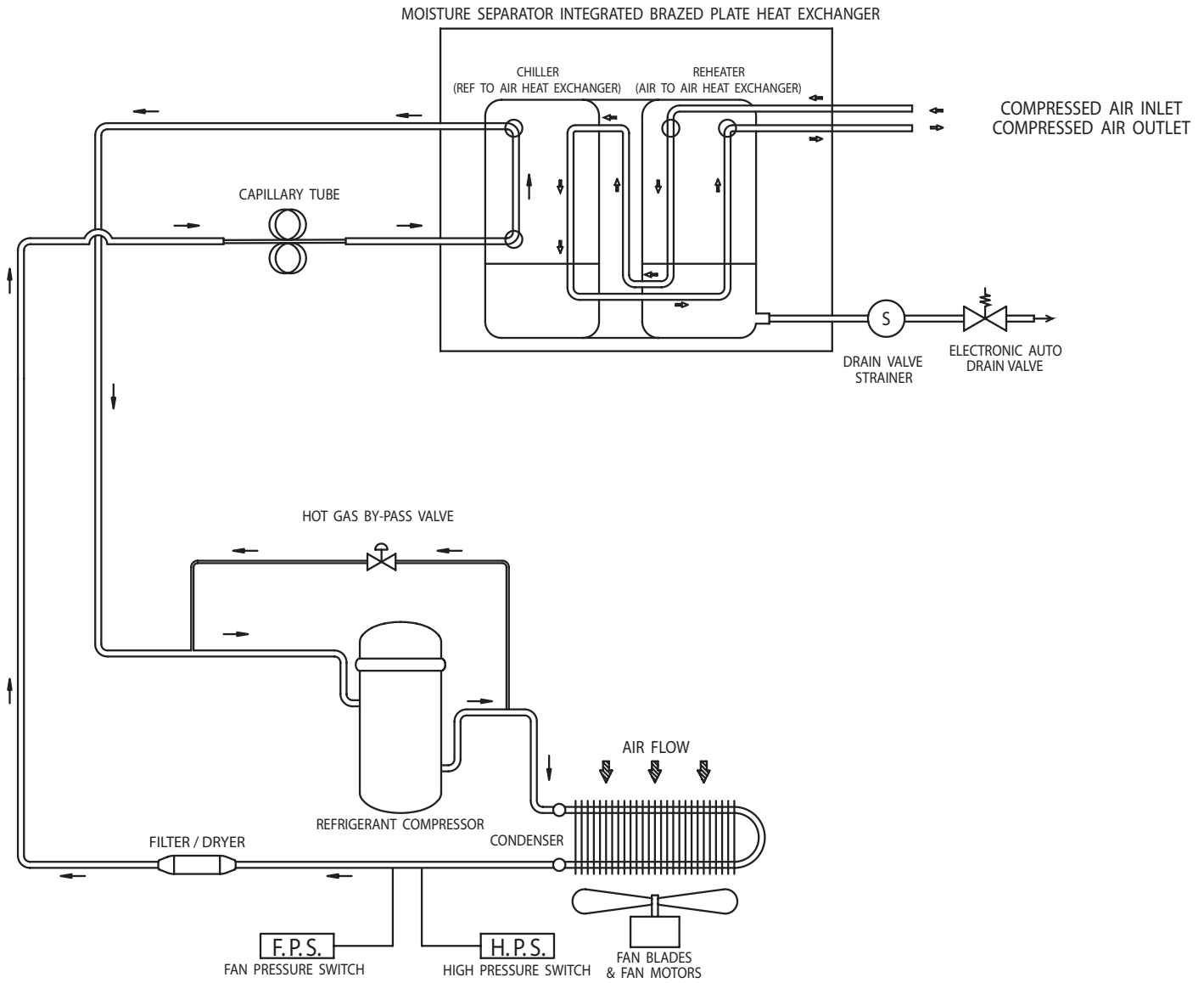

Figure 2b
200 - 500 scfm model

REPLACEMENT PARTS

ITEM	DESCRIPTION	75 SCFM	100 SCFM	125 SCFM	150 SCFM
1	Refrigerant Compressor	3149274	3161249	3161249	3161250
2	Condenser (air-cooled)	1283269	3161253	3161253	3161254
3	Fan Blades	3041954	3041954	3041954	3041954
4	Fan Motor	3161257	3161257	3161257	3161258
5	Filter/Dryer	3161259	1283273	1283273	1283273
6	Solenoid Valve Assembly	3161263	3161263	3161263	3161263
7	Solenoid Valve Timer	3161264	3161264	3161264	3161264
8	Solenoid Valve Strainer	3161265	3161265	3161265	3161265
9	Din Socket	3161266	3161266	3161266	3161266
10	On/Off Switch with Running Lamp	3161244	3161244	3161244	3161244
11	Dew Point Indicator	3041493	3041493	3041493	3041493
12	Hot Gas By-pass Valve	3161268	3161268	3161269	3161270
13	Heat Exchanger	3161275	3161276	3161277	3161277
14	Ambient Air Filter	—	3161260	3161260	3161260
15	Fan Pressure Switch	3161274	3161274	3161274	3161274

ITEM	DESCRIPTION	200 SCFM	250 SCFM	300 SCFM	400 SCFM	500 SCFM
1	Refrigerant Compressor	3161251	3093041	3137014	3090708	3161242
2	Condenser (air-cooled)	3161255	3161255	3161256	3161256	3161245
3	Fan Blades	3041955	3041955	3041957	3041957	3041957
4	Fan Motor	5000011	5000011	5000011	5000011	5000011
5	Filter/Dryer	1283273	1283273	1283369	1283369	1283369
6	Solenoid Valve Assembly	3161248	3161248	3161248	3161248	3161248
7	Solenoid Valve Timer	—	—	—	—	—
8	Solenoid Valve Strainer	3146976	3146976	3146976	3146976	3146976
9	Din Socket	3161267	3161267	3161267	3161267	3161267
10	Hot Gas By-pass Valve	3161271	3161271	3161271	3161272	3161272
11	On/Off Switch with Running Lamp	3161244	3161244	3161244	3161244	3161244
12	High Pressure Switch	3161273	3161273	3161273	3161273	3161273
13	Fan Pressure Switch	3161274	3161274	3161274	3161274	3161274
14	Dryer System Monitor (DSM)	3161282	3161282	3161282	3161282	3161282
15	Heat Exchanger	3161278	3161279	3161280	3161281	3161246
16	Ambient Air Filter	3161261	3161261	3161262	3161262	3161247

NOTES

WARRANTY

The manufacturer warrants the product manufactured by it, when properly installed, operated, applied, and maintained in accordance with procedures and recommendations outlined in manufacturer's instruction manuals, to be free from defects in material or workmanship for a period as specified below, provided such defect is discovered and brought to the manufacturer's attention within the aforesaid warranty period.

The manufacturer will repair or replace any product or part determined to be defective by the manufacturer within the warranty period, provided such defect occurred in normal service and not as a result of misuse, abuse, neglect or accident. Normal maintenance items requiring routine replacement are not warranted. The warranty covers parts and labor for the warranty period unless otherwise specified. Repair or replacement shall be made at the factory or the installation site, at the sole option of the manufacturer. Any service performed on the product by anyone other than the manufacturer must first be authorized by the manufacturer.

Unauthorized service voids the warranty and any resulting charge or subsequent claim will not be paid. Products repaired or replaced under warranty shall be warranted for the unexpired portion of the warranty applying to the original product.

The foregoing is the exclusive remedy of any buyer of the manufacturer's product. The maximum damages liability of the manufacturer is the original purchase price of the product or part.

THE FOREGOING WARRANTY IS EXCLUSIVE AND IN LIEU OF ALL OTHER WARRANTIES, WHETHER WRITTEN, ORAL, OR STATUTORY, AND IS EXPRESSLY IN LIEU OF THE IMPLIED WARRANTY OF MERCHANTABILITY AND THE IMPLIED WARRANTY OF FITNESS FOR A PARTICULAR PURPOSE. THE MANUFACTURER SHALL NOT BE LIABLE FOR LOSS OR DAMAGE BY REASON OF STRICT LIABILITY IN TORT OR ITS NEGLIGENCE IN WHATEVER MANNER INCLUDING DESIGN, MANUFACTURE OR INSPECTION OF THE EQUIPMENT OR ITS FAILURE TO DISCOVER, REPORT, REPAIR, OR MODIFY LATENT DEFECTS INHERENT THEREIN.

THE MANUFACTURER, HIS REPRESENTATIVE OR DISTRIBUTOR SHALL NOT BE LIABLE FOR LOSS OF USE OF THE PRODUCT OR OTHER INCIDENTAL OR CONSEQUENTIAL COSTS, EXPENSES, OR DAMAGES INCURRED BY THE BUYER, WHETHER ARISING FROM BREACH OF WARRANTY, NEGLIGENCE OR STRICT LIABILITY IN TORT.

The manufacturer does not warrant any product, part, material, component, or accessory manufactured by others and sold or supplied in connection with the sale of manufacturer's products.

Warranty Period

Parts and labor for two (2) years from the date of shipment from the factory; heat exchangers are covered (parts only) for an additional three (3) years (total of five [5]). On units that manufacturer requests be returned to the factory, a one time removal/reinstallation labor allowance as noted in the Service Warranty Policies and Procedures Handbook will apply. Freight to the factory from the installation site and to the installation site from the factory will be paid by the manufacturer; means of transportation to be specified by manufacturer.

AUTHORIZATION FROM THE SERVICE DEPARTMENT IS NECESSARY BEFORE MATERIAL IS RETURNED TO THE FACTORY OR IN-WARRANTY REPAIRS ARE MADE.

SERVICE DEPARTMENT: (724) 746-1100

SPX DELTECH

SPX Air Treatment
1000 Philadelphia Street
Canonsburg, PA 15317-1700 U.S.A.
Phone: 724-745-8647 • Fax: 724-745-4967
Email: deltech.inquiry@airtreatment.spx.com
www.deltech-spx.com

SPX Air Treatment Canada
1415 California Avenue
Brockville, ON, Canada, K6V 7H7
Phone: 613-345-2280 • Fax: 613-345-7240
Email: deltech.inquiry@spxairtreatment.ca
www.deltech-spx.com