

### Series MA-63

Type designation **MEM-M18PS/H10-KL2**

Item number **6372263098**

#### Wiring diagram

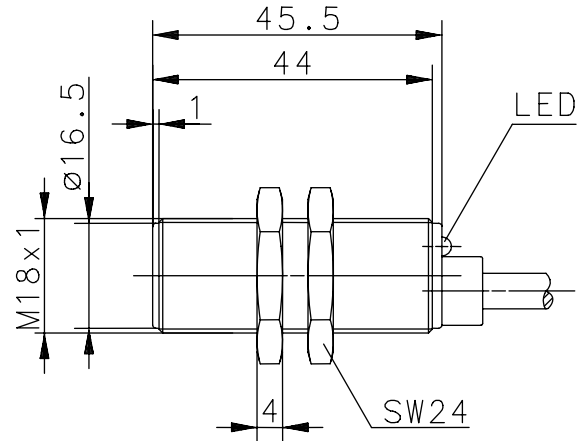
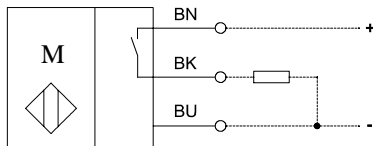

#### Characteristic features in accordance with EN 60947-5-2

##### Electrical data

Assured operating distance	S <sub>a</sub>	17 mm
Switching function		PNP, N.O.
Operational voltage range	U <sub>B</sub>	10-39 VDC
Switching current		400 mA
Supply current		< 20 mA
Voltage drop	U <sub>d</sub>	< 3 V
Switching element		Hall (south activated), typ. 10 mT
Short-circuit protection		pulsed
Frequency of operating cycles	f	10 kHz
Assembly position		optional
False polarity protection		yes
Corresponding magnet		T-62 N/S

##### Electromagnetic compatibility (EMC)

Electromagnetic field test	IEC 61000-4-3
Electrostatic discharge test	IEC 61000-4-2
Electrical fast transient immunity test (Burst)	IEC 61000-4-4
Radiated disturbance field strength	EN 55011

##### Mechanical Data

Enclosure	CuZn39Pb3
Front cap	PA 6.6
Ambient air temperature	-25 °C ... +70 °C (cabel fixed mounted)
Type of protection	IP67 acc. to IEC 529, EN 60529
Indication	LED, yellow; output activated
Termination type	cabel 3 x 0,14 mm <sup>2</sup> x 2 m; PVC-Outer jacket, black
For attachment	2 x hexagon nut

##### EU Conformity



This document will not become the contractual basis; the details included herein do not constitute any descriptions of expected conditions, so that warranties/claims for defects on account of possible variations of the actual from the here described condition are excluded. Subject to modifications and amendments.

Date of issue: 14.02.2008 / Page 1 of 1  
Document: 6372263098\_en.doc / Last update: 1 / 0048-08